



OKAPOVÝ SYSTÉM PŮLKRUHOVÝ



CENÍK
2023

DOPORUČENÉ SPOTŘEBITELSKÉ CENY



POWERFUL PARTNER FOR YOUR ROOF



Hliníkový materiál | 5



Žlab | 7

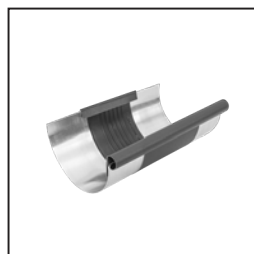

Žlabová dilatace | 9



Žlab příslušenství | 12



Žlabový hák | 14



Roh | 17



Čelo žlabové | 19



Kotlík žlabový | 20

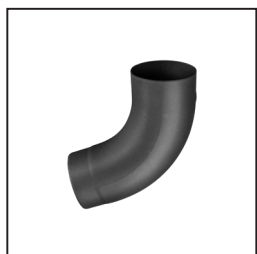

Koleno | 30

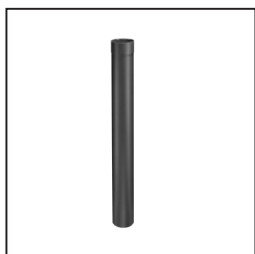

Svodová roura | 33



Svodová roura příslušenství | 35



Objímka | 37

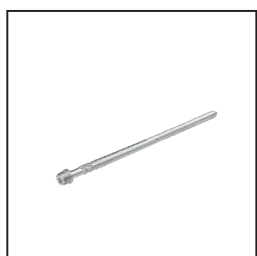

Objímka příslušenství | 38



Dešťová klapka | 40



Svod ochranný | 42

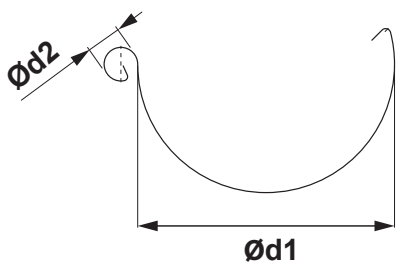

ROZMĚRY STŘEŠNÍCH ŽLABŮ

(rozměry a rozměrové tolerance podle EN 612)

Rozvinutá šířka (mm)	250	280	333
Ød1	105	127	153
Ød2	18	18	20

VNITŘNÍ FALZ

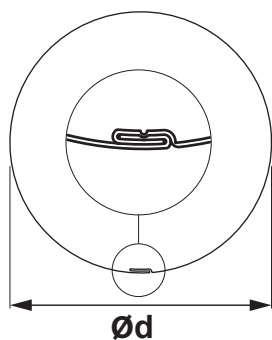

ROZMĚRY STŘEŠNÍCH SVODŮ

(rozměry a rozměrové tolerance podle EN 612)

Rozměry	80	100	120
Jmenovitá velikost Ød (mm)	80	100	120

ROZMĚRY STŘEŠNÍCH HÁKŮ

(rozměry a rozměrové tolerance podle EN 612)

Rozměry (mm)	L1	Ød
250	310	105
280	337	127
333 – 550	385	153

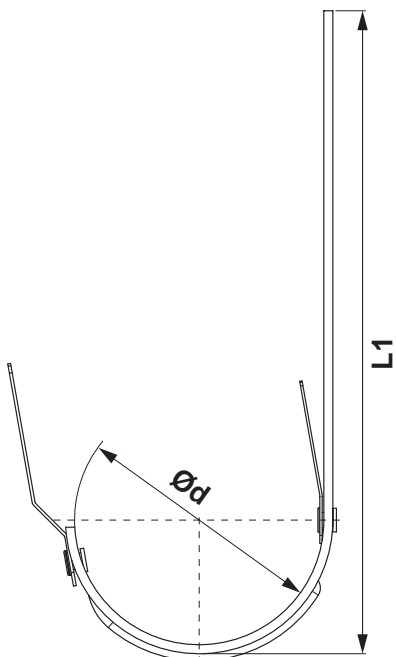

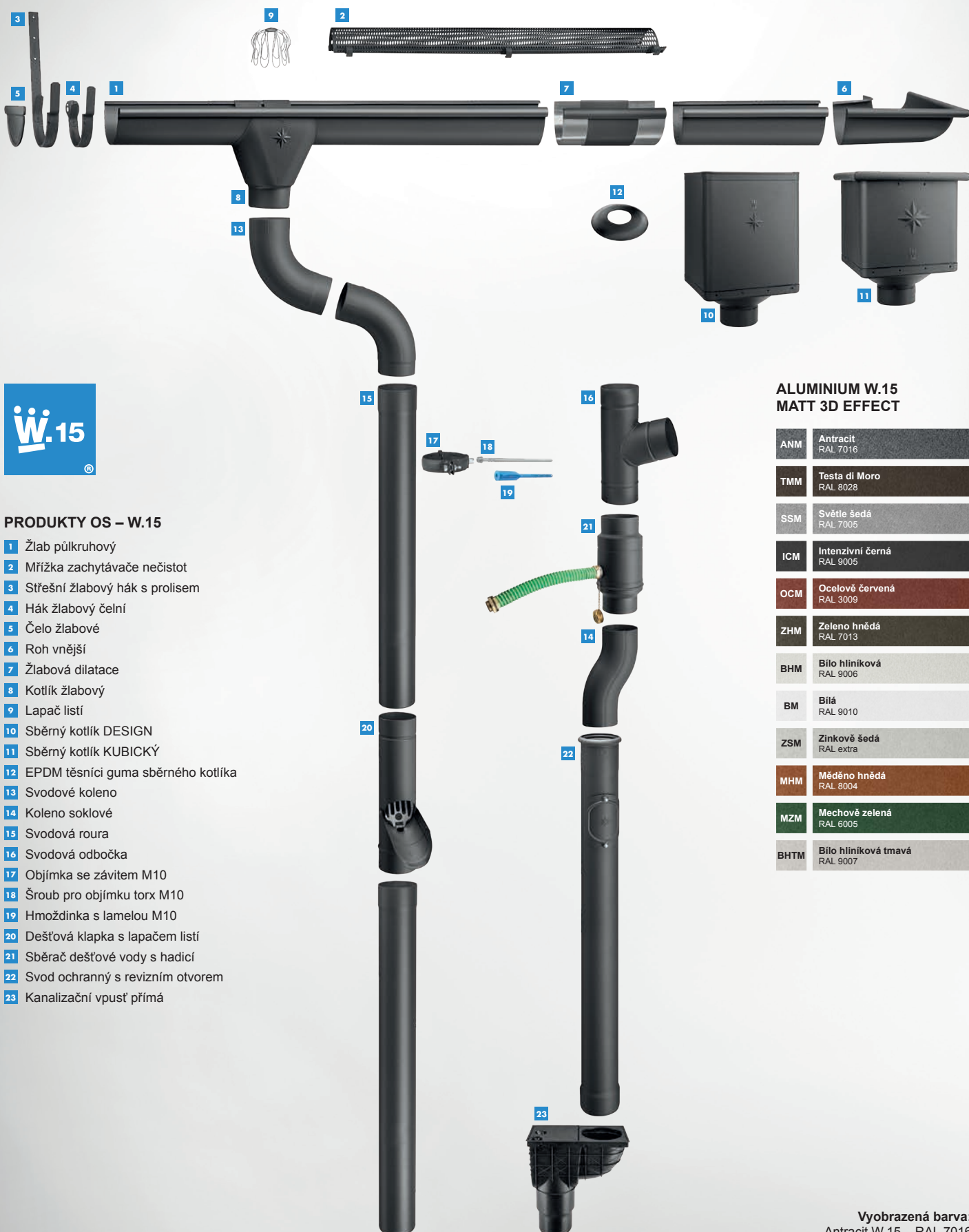

PRODUKTY OS – W.15

- 1 Žlab půlkruhový
- 2 Mřížka zachytávající nečistoty
- 3 Střešní žlabový hák s prolisem
- 4 Háček žlabový čelní
- 5 Čelo žlabové
- 6 Roh vnější
- 7 Žlabová dilatace
- 8 Kotlík žlabový
- 9 Lapač listí
- 10 Sběrný kotlík DESIGN
- 11 Sběrný kotlík KUBICKÝ
- 12 EPDM těsnící guma sběrného kotlíka
- 13 Svodové koleno
- 14 Koleno soklové
- 15 Svodová roura
- 16 Svodová odbočka
- 17 Objímka se závitem M10
- 18 Šroub pro objímku torx M10
- 19 Hmoždinka s lamelou M10
- 20 Dešťová klapka s lapačem listí
- 21 Sběrač dešťové vody s hadicí
- 22 Svod ochranný s revizním otvorem
- 23 Kanalizační vpust' přímá

ALUMINIUM W.15 MATT 3D EFFECT

ANM	Antracit RAL 7016
TMM	Testa di Moro RAL 8028
SSM	Světle šedá RAL 7005
ICM	Intenzivní černá RAL 9005
OCM	Ocelově červená RAL 3009
ZHM	Zeleně hnědá RAL 7013
BHM	Bílo hliníková RAL 9006
BM	Bílá RAL 9010
ZSM	Zinkově šedá RAL extra
MHM	Měděno hnědá RAL 8004
MZM	Mechově zelená RAL 6005
BHTM	Bílo hliníková tmavá RAL 9007





ALUMINIUM W.15 MATT 3D EFFECT

SPEIRA

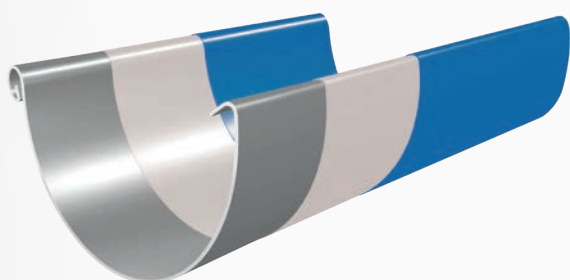
Speira je globální společnost pro válcování a recyklaci hliníku. Skládá se ze sedmi výrobních závodů a jednoho výzkumného a vývojového centra. Nacházející se v Německu a Norsku včetně našeho společného podniku Alunorf, největší válcovny hliníku na světě, Grevenbroich, největší dokončovací válcovny hliníku na světě, jakož i několika mezinárodních prodejních kanceláří. Speira zaměstnává kolem 5 000 lidí hlavně v Německu a Norsku.



-  Vrchní lakovaná vrstva (cca 20 μm) na polyuretanové bázi pro výbornou optiku a nejvyšší odolnost vůči poškození, MATT 3D effect
-  Primer (cca 5 μm) pro perfektní přilnavost a pevnou ochranu
-  Optimalizovaný hliníkový pás pro okapový systém OS – W.15

KJG

SPACE

®

HLINÍKOVÝ MATERIÁL S ELEGANTNÍM MATNÝM POVRCHEM



W.15

✦ Kvalitní barva
s lotosovým efektem

✦ Vysoká odolnost
proti poškrábání

✦ Vysoká barevná
konzistence



✦ W.15 – dvanáct
barevných provedení

✦ 40 let záruka
na materiál a barvu



ŽLAB PŮLKRUHOVÝ [s=0,70]

W.15-WZ

Jmenovitá velikost	250	280	333	333
Délka v m	4,0	4,0	4,0	6,0
Cena v CZK/m	S DPH	S DPH	S DPH	S DPH
ANM Antracit RAL 7016	1 208,00	208,00	263,00	264,00
	094001	094018	094025	094032
TMM Testa di Moro RAL 8028	2 208,00	208,00	263,00	264,00
	100030	100047 *	100054	100061
SSM Světle šedá RAL 7005	3 208,00	208,00	263,00	264,00
	099990	100009	100016	100023
ICM Intenzivní černá RAL 9005	4 208,00	208,00	263,00	264,00
	114662	114679	114686	114693
OCM Ocelově červená RAL 3009	5 208,00	208,00	263,00	264,00
	114709	114716 *	114723 *	114730
ZHM Zeleno hnědá RAL 7013	6 208,00	208,00	263,00	264,00
	111982	111999	112002	112019
BHM Bílo hliníková RAL 9006	7 208,00	208,00	263,00	264,00
	114624	114631 *	114648	114655
BM Bílá RAL 9010	8 208,00	208,00	263,00	264,00
	132833 *	132888 *	132932	132949
ZSM Zinkově šedá RAL extra	9 208,00	208,00	263,00	264,00
	132796 *	132840 *	132895 *	132987 *
MHM Měděno hnědá RAL 8004	10 208,00	208,00	263,00	264,00
	132819 *	132864 *	132918 *	132963 *
MZM Mechově zelená RAL 6005	11 208,00	208,00	263,00	264,00
	132802 *	132857 *	132901 *	132970 *
BHTM Bílo hliníková tmavá RAL 9007	12 208,00	208,00	263,00	264,00
	132826 *	132871 *	132925 *	132956 *
Balení v m 	20	20	20	30
Balení v m 	960	840	660	990

* Výroba na objednávku





ALUMINIUM W.15

MATT 3D EFFECT

ŽLAB NÁSTŘEŠNÍ [s=0,70]

W.15-WZS



Jmenovitá velikost		650
Délka v m		6,0
Cena v CZK/m		S DPH
ANM Antracit RAL 7016	1	681,00 094179
TMM Testa di Moro RAL 8028	2	681,00 100214 *
SSM Světle šedá RAL 7005	3	681,00 100221 *
ICM Intenzivní černá RAL 9005	4	681,00 114471 *
OCM Ocelově červená RAL 3009	5	681,00 114488 *
ZHM Zeleno hnědá RAL 7013	6	681,00 112125 *
BHM Bílo hliníková RAL 9006	7	681,00 114495 *
BM Bílá RAL 9010	8	681,00 137500 *
ZSM Zinkově šedá RAL extra	9	681,00 137531 *
MHM Měděno hnědá RAL 8004	10	681,00 137517 *
MZM Mechově zelená RAL 6005	11	681,00 137524 *
BHTM Bílo hliníková tmavá RAL 9007	12	681,00 137494 *
Balení v m 		6
Balení v m 		300

* Výroba na objednávku



ŽLABOVÁ DILATACE

W.15-WZDI

Jmenovitá velikost	250/260	285/260	333/260
Cena v CZK/ks	S DPH	S DPH	S DPH
ANM 1 Antracit RAL 7016	722,00 093356 *	757,00 093363 *	757,00 093370
TMM 2 Testa di Moro RAL 8028	722,00 098702 *	757,00 098719 *	757,00 098726
SSM 3 Světle šedá RAL 7005	722,00 098818 *	757,00 098825 *	757,00 098832 *
ICM 4 Intenzivní černá RAL 9005	722,00 118738 *	757,00 118745 *	757,00 118752
OCM 5 Ocelově červená RAL 3009	722,00 118769 *	757,00 118776 *	757,00 118783 *
ZHM 6 Zeleno hnědá RAL 7013	722,00 111401 *	757,00 111418 *	757,00 111432
BHM 7 Bílo hliníková RAL 9006	722,00 118707 *	757,00 118714 *	757,00 118721 *
BM 8 Bílá RAL 9010	722,00 137029 *	757,00 137036 *	757,00 137043 *
ZSM 9 Zinkově šedá RAL extra	722,00 137111 *	757,00 137128 *	757,00 137135 *
MHM 10 Méděno hnědá RAL 8004	722,00 137050 *	757,00 137067 *	757,00 137074 *
MZM 11 Mechově zelená RAL 6005	722,00 137081 *	757,00 137098 *	757,00 137104 *
BHTM 12 Bílo hliníková tmavá RAL 9007	722,00 136992 *	757,00 137005 *	757,00 137012 *
Balení v ks 	3	3	5
Balení v ks 	360	360	200

* Výroba na objednávku

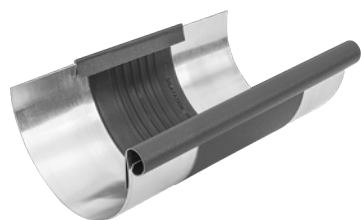

ALUMINIUM W.15



MATT 3D EFFECT

DILATACE NÁSTŘEŠNÍHO ŽLABU

W.15-WZSDI



ALUMINIUM
W.15

Jmenovitá velikost	670/260
Cena v CZK/ks	S DPH
ANM 1 Antracit RAL 7016	2 290,00 093400 *
TMM 2 Testa di Moro RAL 8028	2 290,00 098757 *
SSM 3 Světle šedá RAL 7005	2 290,00 098863 *
ICM 4 Intenzivní černá RAL 9005	2 290,00 118806 *
OCM 5 Ocelově červená RAL 3009	2 290,00 118813 *
ZHM 6 Zeleno hnědá RAL 7013	2 290,00 111425 *
BHM 7 Bílo hliníková RAL 9006	2 290,00 118790 *
BM 8 Bílá RAL 9010	2 290,00 137555 *
ZSM 9 Zinkově šedá RAL extra	2 290,00 137586 *
MHM 10 Měděno hnědá RAL 8004	2 290,00 137562 *
MZM 11 Mechově zelená RAL 6005	2 290,00 137579 *
BHTM 12 Bílo hliníková tmavá RAL 9007	2 290,00 137548 *
Balení v ks 	1
Balení v ks 	40

* Výroba na objednávku

POUŽITÍ DILATAČNÍHO ŽLABU A PÁSOVÉ DILATACE

DILATAČNÍ ŽLAB

Příklad montáže: Podokapový žlab o rozvinuté šířce do 500 mm. Dilatační žlab musí být namontován v rozestupu 15 m. Pro vnější roh a začátek žlabu platí polovina standardní hodnoty: maximálně 7,5 m. Pro vnitřní roh platí čtvrtina standardní hodnoty: maximálně 3,75 m. Pro ostatní materiály a rozměry: viz tabulka níže. Rohy se vždy počítají jako pevné body.

STŘEŠNÍ PŮLKRUHOVÉ DILATAČNÍ ŽLABY

Rozvinutá šířka žlabu	Hliník	Pozink, Titan-zinek, Měď, Nerez
< 500	12	15
> 500	8	10

PÁSOVÁ DILATACE

Vnitřní instalace: na žlaby uchycené bez lepení na podklad, střechy s nestandardním profilem a oplechování zdiva.

STŘEŠNÍ PÁSOVÁ DILATACE

Rozvinutá šířka žlabu	Hliník	Pozink, Titan-zinek, Měď, Nerez
< 500	8	10
> 500	6	8

Pre vonkajší roh alebo začiatok žlabu platí polovica štandardnej hodnoty. Pre vnútorný roh platí jedna štvrtina štandardnej hodnoty.

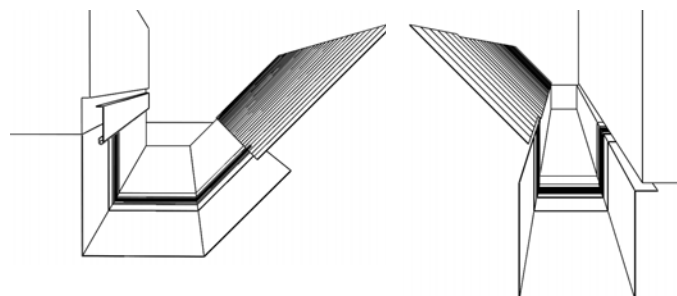
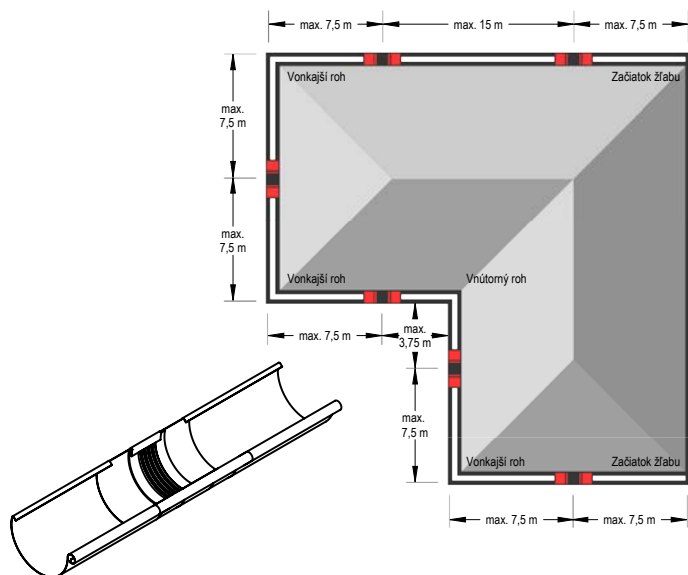

Poznámka k montáži dilatačního pásu.

Při ohýbání a montáži dilatačních prvků se ujistěte, že:

- ohýbací čelisti mají rádius minimálně 2 mm.
- pro tloušťku plechu od 1 mm musí být dodržen poloměr ohybu minimálně 5 mm.
- ohýbací čelisti musí být při ohýbání nastaveny na tloušťku střední gumové části 3 až 4 mm, aby se zabránilo stříhacího efektu - poškození gumy.
- Gumová střední část nesmí být během ohýbání stlačena nebo poškozená. Proto by měl být použit hliníkový plechový pás 2 až 5 mm (hrubý) ohnutý tak, aby mohl být připevněn jako ochrana na ohýbací čelisti. Tím se dosáhne větší poloměr ohybu a zabrání se porušení gumové střední části.

Poznámka k montáži dilatačního žlabu.

Při montáži pomocí pájení nejprve střední gumový díl překryjte mokrým hadříkem (aby nedošlo k prostupu tepla do středního gumového dílu). Musí se dodržet minimální vzdálenost 6 cm od střední gumové části. V každém případě je třeba se vyhnout kontaktu gumy s otevřeným plamenem.

ALUMINIUM W.15

MATT 3D EFFECT

MŘÍŽKA ZACHYTÁVAČE NEČISTOT

W.15-WZNL M

Jmenovitá velikost		333
Délka v m		2,0
Cena v CZK/ks		S DPH
ANM Antracit RAL 7016	1	915,00 097149 *
TMM Testa di Moro RAL 8028	2	915,00 118035 *
SSM Světle šedá RAL 7005	3	915,00 118028 *
ICM Intenzivní černá RAL 9005	4	915,00 118004 *
OCM Ocelově červená RAL 3009	5	915,00 118011 *
ZHM Zeleno hnědá RAL 7013	6	915,00 118042 *
BHM Bílo hliníková RAL 9006	7	915,00 117991 *
BM Bílá RAL 9010	8	915,00 137142 *
ZSM Zinkově šedá RAL extra	9	915,00 137173 *
MHM Měděno hnědá RAL 8004	10	915,00 137159 *
MZM Mechově zelená RAL 6005	11	915,00 137166 *
BHTM Bílo hliníková tmavá RAL 9007	12	915,00 137180 *
Balení v ks		15
Balení v ks		120

* Výroba na objednávku

ALUMINIUM
W.15

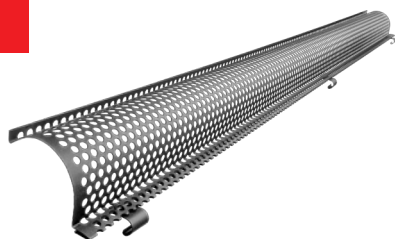



ALUMINIUM W.15

MATT 3D EFFECT



PVC MŘÍŽKA ZACHYTÁVAČE LISTÍ

SD-ZNL MRIEZKA

Jmenovitá velikost	Délka v m	EAN číslo výrobku	Balení v ks		Cena s DPH [CZK/ks]
					
PS 171	1,0	008473	30	450	152,00
TM 171	1,0	008466	30	450	152,00

PVC MŘÍŽKA ZACHYTÁVAČE LISTÍ



SD-ZNL N

Jmenovitá velikost	Délka v m	EAN číslo výrobku	Balení v ks		Cena s DPH [CZK/ks]
					
250	3,0	008480	10	400	810,00
280-333	3,0	008497	10	400	813,00



STŘEŠNÍ ŽLABOVÝ HÁK S PROLISEM

W.15-WHP

Jmenovitá velikost	250/430	280/480	333/550
Materiál	23/7	28/7	28/7
Cena v CZK/ks	S DPH	S DPH	S DPH
ANM 1 Antracit RAL 7016	120,00 093455	137,00 093462	151,00 093479
TMM 2 Testa di Moro RAL 8028	120,00 098986	137,00 098993	151,00 099006
SSM 3 Světle šedá RAL 7005	120,00 098955	137,00 098962	151,00 098979
ICM 4 Intenzivní černá RAL 9005	120,00 116475	137,00 116482	151,00 116499
OCM 5 Ocelově červená RAL 3009	120,00 116505	137,00 116512 *	151,00 116529
ZHM 6 Zeleno hnědá RAL 7013	120,00 111449	137,00 111456	151,00 111463
BHM 7 Bílo hliníková RAL 9006	120,00 116444 *	137,00 116451 *	151,00 116468
BM 8 Bílá RAL 9010	120,00 133083 *	137,00 133090 *	151,00 133106
ZSM 9 Zinkově šedá RAL extra	120,00 133175 *	137,00 133182 *	151,00 133199 *
MHM 10 Měděno hnědá RAL 8004	120,00 133113	137,00 133120 *	151,00 133137
MZM 11 Mechově zelená RAL 6005	120,00 133144 *	137,00 133151 *	151,00 133168 *
BHTM 12 Bílo hliníková tmavá RAL 9007	120,00 133052 *	137,00 133069 *	151,00 133076 *
Balení v ks 	15	15	15
Balení v ks 	600	600	600



* Výroba na objednávku



HÁK ŽLABOVÝ ČELNÍ

W.15-WHPK



Jmenovitá velikost	250	280	333
Materiál	28/7	28/7	28/7
Cena v CZK/ks	S DPH	S DPH	S DPH
ANM Antracit RAL 7016	136,00	137,00	139,00
	093486	093493	093509
TMM Testa di Moro RAL 8028	136,00	137,00	139,00
	099020 *	099044 *	099068
SSM Světle šedá RAL 7005	136,00	137,00	139,00
	099013 *	099037 *	099051
ICM Intenzivní černá RAL 9005	136,00	137,00	139,00
	118448 *	118455 *	118462 *
OCM Ocelově červená RAL 3009	136,00	137,00	139,00
	118479 *	118486 *	118493 *
ZHM Zeleno hnědá RAL 7013	136,00	137,00	139,00
	111470 *	111487 *	111494
BHM Bílo hliníková RAL 9006	136,00	137,00	139,00
	118417 *	118424 *	118431 *
BM Bílá RAL 9010	136,00	137,00	139,00
	133250 *	133267 *	133274 *
ZSM Zinkově šedá RAL extra	136,00	137,00	139,00
	133342 *	133359 *	133366 *
MHM Měděno hnědá RAL 8004	136,00	137,00	139,00
	133281 *	133298 *	133304 *
MZM Mechově zelená RAL 6005	136,00	137,00	139,00
	133311 *	133328 *	133335 *
BHTM Bílo hliníková tmavá RAL 9007	136,00	137,00	139,00
	133229 *	133236 *	133243 *
Balení v ks 	15	15	15
Balení v ks 	600	600	600



* Výroba na objednávku

ALUMINIUM W.15

MATT 3D EFFECT

HÁK ŽLABOVÝ NÁSTRĚŠNÍ

W.15-WHSG

Jmenovitá velikost	4
Materiál	28/7
Cena v CZK/ks	S DPH
ANM 1 Antracit RAL 7016	315,00 093516
TMM 2 Testa di Moro RAL 8028	315,00 099082 *
SSM 3 Světle šedá RAL 7005	315,00 099075 *
ICM 4 Intenzivní černá RAL 9005	315,00 114600 *
OCM 5 Ocelově červená RAL 3009	315,00 114617 *
ZHM 6 Zeleno hnědá RAL 7013	315,00 111500 *
BHM 7 Bílo hliníková RAL 9006	315,00 114594 *
BM 8 Bílá RAL 9010	315,00 135605 *
ZSM 9 Zinkově šedá RAL extra	315,00 135636 *
MHM 10 Měděno hnědá RAL 8004	315,00 135612 *
MZM 11 Mechově zelená RAL 6005	315,00 135629 *
BHTM 12 Bílo hliníková tmavá RAL 9007	315,00 135599 *
Balení v ks 	10
Balení v ks 	400



* Výroba na objednávku



ALUMINIUM
W.15

ROH VNĚJŠÍ

W.15-WRA

Jmenovitá velikost	250	280	333
Cena v CZK/ks	S DPH	S DPH	S DPH
ANM 1 Antracit RAL 7016	522,00 093905	545,00 093912	571,00 093929
TMM 2 Testa di Moro RAL 8028	522,00 099822	545,00 099839 *	571,00 099846
SSM 3 Světle šedá RAL 7005	522,00 099792	545,00 099808	571,00 099815
ICM 4 Intenzivní černá RAL 9005	522,00 118868	545,00 118875	571,00 118882
OCM 5 Ocelově červená RAL 3009	522,00 118899 *	545,00 118905 *	571,00 118912 *
ZHM 6 Zeleno hnědá RAL 7013	522,00 111876	545,00 111883 *	571,00 111890
BHM 7 Bílo hliníková RAL 9006	522,00 118837 *	545,00 118844 *	571,00 118851 *
BM 8 Bílá RAL 9010	522,00 136725 *	545,00 136732 *	571,00 136749
ZSM 9 Zinkově šedá RAL extra	522,00 136817 *	545,00 136824 *	571,00 136831 *
MHM 10 Měděno hnědá RAL 8004	522,00 136756	545,00 136763 *	571,00 136770
MZM 11 Mechově zelená RAL 6005	522,00 136787 *	545,00 136794 *	571,00 136800 *
BHTM 12 Bílo hliníková tmavá RAL 9007	522,00 136695 *	545,00 136701 *	571,00 136718 *
Balení v ks 	5	5	5
Balení v ks 	150	150	150

* Výroba na objednávku

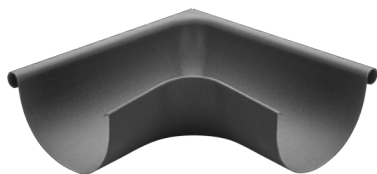



ALUMINIUM W.15

MATT 3D EFFECT

ROH VNITŘNÍ

W.15-WRI

Jmenovitá velikost	250	280	333
Cena v CZK/ks	S DPH	S DPH	S DPH
ANM 1 Antracit RAL 7016	522,00 093950	545,00 093967	571,00 093974
TMM 2 Testa di Moro RAL 8028	522,00 099884 *	545,00 099891 *	571,00 099907
SSM 3 Světle šedá RAL 7005	522,00 099853	545,00 099860	571,00 099877
ICM 4 Intenzivní černá RAL 9005	522,00 118950 *	545,00 118967 *	571,00 118974
OCM 5 Ocelově červená RAL 3009	522,00 118981 *	545,00 118998 *	571,00 119001 *
ZHM 6 Zeleno hnědá RAL 7013	522,00 111906 *	545,00 111913 *	571,00 111920
BHM 7 Bílo hliníková RAL 9006	522,00 118929 *	545,00 118936 *	571,00 118943 *
BM 8 Bílá RAL 9010	522,00 136879 *	545,00 136886 *	571,00 136893
ZSM 9 Zinkově šedá RAL extra	522,00 136961 *	545,00 136978 *	571,00 136985 *
MHM 10 Měděno hnědá RAL 8004	522,00 136909 *	545,00 136916 *	571,00 136923
MZM 11 Mechově zelená RAL 6005	522,00 136930 *	545,00 136947 *	571,00 136954 *
BHTM 12 Bílo hliníková tmavá RAL 9007	522,00 136848 *	545,00 136855 *	571,00 136862 *
Balení v ks 	5	5	5
Balení v ks 	150	150	150

* Výroba na objednávku



ČELO ŽLABOVÉ

W.15-WCL



Jmenovitá velikost	250	280	333
Cena v CZK/ks	S DPH	S DPH	S DPH
ANM 1 Antracit RAL 7016	53,00 093301	54,00 093318	56,00 093325
TMM 2 Testa di Moro RAL 8028	53,00 098658 *	54,00 098665 *	56,00 098672
SSM 3 Světle šedá RAL 7005	53,00 098764	54,00 098771	56,00 098788
ICM 4 Intenzivní černá RAL 9005	53,00 118356	54,00 118363	56,00 118370
OCM 5 Ocelově červená RAL 3009	53,00 118387 *	54,00 118394 *	56,00 118400
ZHM 6 Zeleno hnědá RAL 7013	53,00 111371 *	54,00 111388 *	56,00 111395
BHM 7 Bílo hliníková RAL 9006	53,00 118325 *	54,00 118332 *	56,00 118349
BM 8 Bílá RAL 9010	53,00 135476 *	54,00 135483 *	56,00 135490
ZSM 9 Zinkově šedá RAL extra	53,00 135568 *	54,00 135575 *	56,00 135582 *
MHM 10 Měděno hnědá RAL 8004	53,00 135506	54,00 135513 *	56,00 135520
MZM 11 Mechově zelená RAL 6005	53,00 135537 *	54,00 135544 *	56,00 135551 *
BHTM 12 Bílo hliníková tmavá RAL 9007	53,00 135445 *	54,00 135452 *	56,00 135469 *
Balení v ks 	6/60	6/60	6/60
Balení v ks 	1 440	1 440	1 440



* Výroba na objednávku

ALUMINIUM W.15

MATT 3D EFFECT

KOTLÍK ŽLABOVÝ

W.15-WKL

Jmenovitá velikost	250/80	280/80	280/100
Cena v CZK/ks	S DPH	S DPH	S DPH
ANM 1 Antracit RAL 7016	398,00 093585	457,00 093592 *	440,00 093608
TMM 2 Testa di Moro RAL 8028	398,00 099273	457,00 099280 *	440,00 099297
SSM 3 Světle šedá RAL 7005	398,00 099211	457,00 099228 *	440,00 099235
ICM 4 Intenzivní černá RAL 9005	398,00 116864	457,00 116871 *	440,00 116888
OCM 5 Ocelově červená RAL 3009	398,00 116925 *	457,00 116932 *	440,00 116949 *
ZHM 6 Zeleno hnědá RAL 7013	398,00 111579	457,00 111586 *	440,00 111593
BHM 7 Bílo hliníková RAL 9006	398,00 116802 *	457,00 116819 *	440,00 116826 *
BM 8 Bílá RAL 9010	398,00 135858 *	457,00 135865 *	440,00 135872 *
ZSM 9 Zinkově šedá RAL extra	398,00 136039 *	457,00 136046 *	440,00 136053 *
MHM 10 Měděno hnědá RAL 8004	398,00 135919	457,00 135926 *	440,00 135933 *
MZM 11 Mechově zelená RAL 6005	398,00 135971 *	457,00 135988 *	440,00 135995 *
BHTM 12 Bílo hliníková tmavá RAL 9007	398,00 135797 *	457,00 135803 *	440,00 135810 *
Balení v ks 	15	15	15
Balení v ks 	300	450	450

* Výroba na objednávku



KOTLÍK ŽLABOVÝ

W.15-WKL

Jmenovitá velikost	333/80	333/100	333/120
Cena v CZK/ks	S DPH	S DPH	S DPH
ANM 1 Antracit RAL 7016	473,00 093615 *	483,00 093622	634,00 093639
TMM 2 Testa di Moro RAL 8028	473,00 099303 *	483,00 099310	634,00 099327
SSM 3 Světle šedá RAL 7005	473,00 099242 *	483,00 099259	634,00 099266
ICM 4 Intenzivní černá RAL 9005	473,00 116895 *	483,00 116901	634,00 116918 *
OCM 5 Ocelově červená RAL 3009	473,00 116956 *	483,00 116963 *	634,00 116970 *
ZHM 6 Zeleno hnědá RAL 7013	473,00 111609 *	483,00 111616	634,00 111623
BHM 7 Bílo hliníková RAL 9006	473,00 116833 *	483,00 116840 *	634,00 116857 *
BM 8 Bílá RAL 9010	473,00 135889 *	483,00 135896	634,00 135902 *
ZSM 9 Zinkově šedá RAL extra	473,00 136060 *	483,00 136077 *	634,00 136084 *
MHM 10 Měděno hnědá RAL 8004	473,00 135940	483,00 135957	634,00 135964
MZM 11 Mechově zelená RAL 6005	473,00 136008 *	483,00 136015 *	634,00 136022 *
BHTM 12 Bílo hliníková tmavá RAL 9007	473,00 135827 *	483,00 135834 *	634,00 135841 *
Balení v ks 	15	15	10
Balení v ks 	450	450	200

* Výroba na objednávku



ALUMINIUM W.15

MATT 3D EFFECT

NOVÝ UPINACÍ
SYSTÉM FEDER UMOŽŇUJE
JEDNODUŠE NATOČIT KOLENO
DO POŽADOVANÉHO SMĚRU,
SPOLEHLIVĚ DRŽÍ V KAŽDÉ
POLOZE. SNADNÁ MONTÁŽ
NA JAKÉKOLIV KOLENO
BEZ NÝTOVÁNÍ.



1



2



3







ALUMINIUM W.15

MATT 3D EFFECT

NEREZOVÝ LPAČ LISTÍ

N-NZN



Jmenovitá velikost	EAN číslo výrobku	Balení v ks		Cena s DPH [CZK/ks]
				
60	001153	30	2 160	188,00
80	001160	20	1 440	190,00
100	001177	15	1 080	193,00
120	001184	10	720	210,00
150	001191	5	360	332,00





ALUMINIUM W.15

MATT 3D EFFECT

SBĚRNÝ KOTLÍK DESIGN

W.15-WKLZ DE

Jmenovitá velikost	80	100	120
Cena v CZK/ks	S DPH	S DPH	S DPH
ANM 1 Antracit RAL 7016	3 520,00 093677 *	3 520,00 093721	3 700,00 093776 *
TMM 2 Testa di Moro RAL 8028	3 520,00 100634 *	3 520,00 100689 *	3 700,00 100733 *
SSM 3 Světle šedá RAL 7005	3 520,00 100481 *	3 520,00 100535 *	3 700,00 100580 *
ICM 4 Intenzivní černá RAL 9005	3 520,00 138606 *	3 520,00 138651 *	3 700,00 138705 *
OCM 5 Ocelově červená RAL 3009	3 520,00 139054 *	3 520,00 139108 *	3 700,00 139153 *
ZHM 6 Zeleno hnědá RAL 7013	3 520,00 111647 *	3 520,00 111692 *	3 700,00 111746 *
BHM 7 Bílo hliníková RAL 9006	3 520,00 138156 *	3 520,00 138200 *	3 700,00 138255 *
BM 8 Bílá RAL 9010	3 520,00 138453 *	3 520,00 138507 *	3 700,00 138552 *
ZSM 9 Zinkově šedá RAL extra	3 520,00 139207 *	3 520,00 139252 *	3 700,00 139306 *
MHM 10 Měděno hnědá RAL 8004	3 520,00 138750 *	3 520,00 138804 *	3 700,00 138859 *
MZM 11 Mechově zelená RAL 6005	3 520,00 138903 *	3 520,00 138958 *	3 700,00 139009 *
BHTM 12 Bílo hliníková tmavá RAL 9007	3 520,00 138309 *	3 520,00 138354 *	3 700,00 138408 *
Balení v ks 	2	2	2
Balení v ks 	36	36	36



* Výroba na objednávku



SBĚRNÝ KOTLÍK DESIGN EXZENTRICKÝ

W.15-WKLZ DX





Jmenovitá velikost	80	100	120
Cena v CZK/ks	S DPH	S DPH	S DPH
ANM 1 Antracit RAL 7016	4 052,00 093660 *	4 052,00 093714	4 404,00 093769 *
TMM 2 Testa di Moro RAL 8028	4 052,00 100627 *	4 052,00 100672 *	4 404,00 100726 *
SSM 3 Světle šedá RAL 7005	4 052,00 100474 *	4 052,00 100528 *	4 404,00 100573 *
ICM 4 Intenzivní černá RAL 9005	4 052,00 138613 *	4 052,00 138668 *	4 404,00 138712 *
OCM 5 Ocelově červená RAL 3009	4 052,00 139061 *	4 052,00 139115 *	4 404,00 139160 *
ZHM 6 Zeleno hnědá RAL 7013	4 052,00 111630 *	4 052,00 111685 *	4 404,00 111739 *
BHM 7 Bílo hliníková RAL 9006	4 052,00 138163 *	4 052,00 138217 *	4 404,00 138262 *
BM 8 Bílá RAL 9010	4 052,00 138460 *	4 052,00 138514 *	4 404,00 138569 *
ZSM 9 Zinkově šedá RAL extra	4 052,00 139214 *	4 052,00 139269 *	4 404,00 139313 *
MHM 10 Méděno hnědá RAL 8004	4 052,00 138767 *	4 052,00 138811 *	4 404,00 138866 *
MZM 11 Mechově zelená RAL 6005	4 052,00 138910 *	4 052,00 138965 *	4 404,00 139016 *
BHTM 12 Bílo hliníková tmavá RAL 9007	4 052,00 138316 *	4 052,00 138361 *	4 404,00 138415 *
Balení v ks 	2	2	2
Balení v ks 	36	36	36

* Výroba na objednávku

SBĚRNÝ KOTLÍK KUBICKÝ

W.15-WKLZ KU

Jmenovitá velikost	80	100	120
Cena v CZK/ks	S DPH	S DPH	S DPH
ANM 1 Antracit RAL 7016	4 509,00 093684 *	4 509,00 093738 *	5 109,00 093783 *
TMM 2 Testa di Moro RAL 8028	4 509,00 100641 *	4 509,00 100696 *	5 109,00 100740 *
SSM 3 Světle šedá RAL 7005	4 509,00 100498 *	4 509,00 100542 *	5 109,00 100597 *
ICM 4 Intenzivní černá RAL 9005	4 509,00 138620 *	4 509,00 138675 *	5 109,00 138729 *
OCM 5 Ocelově červená RAL 3009	4 509,00 139078 *	4 509,00 139122 *	5 109,00 139177 *
ZHM 6 Zeleno hnědá RAL 7013	4 509,00 111654 *	4 509,00 111708 *	5 109,00 111753 *
BHM 7 Bílo hliníková RAL 9006	4 509,00 138170 *	4 509,00 138224 *	5 109,00 138279 *
BM 8 Bílá RAL 9010	4 509,00 138477 *	4 509,00 138521 *	5 109,00 138576 *
ZSM 9 Zinkově šedá RAL extra	4 509,00 139221 *	4 509,00 139276 *	5 109,00 139320 *
MHM 10 Méděno hnědá RAL 8004	4 509,00 138774 *	4 509,00 138828 *	5 109,00 138873 *
MZM 11 Mechově zelená RAL 6005	4 509,00 138927 *	4 509,00 138972 *	5 109,00 139023 *
BHTM 12 Bílo hliníková tmavá RAL 9007	4 509,00 138323 *	4 509,00 138378 *	5 109,00 138422 *
Balení v ks 	2	2	2
Balení v ks 	36	36	36



* Výroba na objednávku



SBĚRNÝ KOTLÍK KUBICKÝ EXZENTRICKÝ

W.15-WKLZ KX



Jmenovitá velikost	80	100	120
Cena v CZK/ks	S DPH	S DPH	S DPH
ANM 1 Antracit RAL 7016	4 757,00 093707 *	4 757,00 093752	5 109,00 093806 *
TMM 2 Testa di Moro RAL 8028	4 757,00 100665 *	4 757,00 100719	5 109,00 100764 *
SSM 3 Světle šedá RAL 7005	4 757,00 100511 *	4 757,00 100566	5 109,00 100610 *
ICM 4 Intenzivní černá RAL 9005	4 757,00 138637 *	4 757,00 138682 *	5 109,00 138736 *
OCM 5 Ocelově červená RAL 3009	4 757,00 139085 *	4 757,00 139139 *	5 109,00 139184 *
ZHM 6 Zeleno hnědá RAL 7013	4 757,00 111678 *	4 757,00 111722	5 109,00 111777 *
BHM 7 Bílo hliníková RAL 9006	4 757,00 138187 *	4 757,00 138231 *	5 109,00 138286 *
BM 8 Bílá RAL 9010	4 757,00 138484 *	4 757,00 138538 *	5 109,00 138583 *
ZSM 9 Zinkově šedá RAL extra	4 757,00 139238 *	4 757,00 139283 *	5 109,00 139337 *
MHM 10 Měděno hnědá RAL 8004	4 757,00 138781 *	4 757,00 138835 *	5 109,00 138880 *
MZM 11 Mechově zelená RAL 6005	4 757,00 138934 *	4 757,00 138989 *	5 109,00 139030 *
BHTM 12 Bílo hliníková tmavá RAL 9007	4 757,00 138330 *	4 757,00 138385 *	5 109,00 138439 *
Balení v ks 	2	2	2
Balení v ks 	36	36	36

* Výroba na objednávku

ALUMINIUM W.15

MATT 3D EFFECT

SBĚRNÝ KOTLÍK KUBICKÝ EXZENTRICKÝ S VÝTOKEM W.15-WKLZ KXV





Jmenovitá velikost	80	100	120
Cena v CZK/ks	S DPH	S DPH	S DPH
ANM 1 Antracit RAL 7016	5 638,00 093691 *	5 638,00 093745 *	5 990,00 093790 *
TMM 2 Testa di Moro RAL 8028	5 638,00 100658 *	5 638,00 100702 *	5 990,00 100757 *
SSM 3 Světle šedá RAL 7005	5 638,00 100504 *	5 638,00 100559 *	5 990,00 100603 *
ICM 4 Intenzivní černá RAL 9005	5 638,00 138644 *	5 638,00 138699 *	5 990,00 138743 *
OCM 5 Ocelově červená RAL 3009	5 638,00 139092 *	5 638,00 139146 *	5 990,00 139191 *
ZHM 6 Zeleno hnědá RAL 7013	5 638,00 111661 *	5 638,00 111715 *	5 990,00 111760 *
BHM 7 Bílo hliníková RAL 9006	5 638,00 138194 *	5 638,00 138248 *	5 990,00 138293 *
BM 8 Bílá RAL 9010	5 638,00 138491 *	5 638,00 138545 *	5 990,00 138590 *
ZSM 9 Zinkově šedá RAL extra	5 638,00 139245 *	5 638,00 139290 *	5 990,00 139344 *
MHM 10 Méděno hnědá RAL 8004	5 638,00 138798 *	5 638,00 138842 *	5 990,00 138897 *
MZM 11 Mechově zelená RAL 6005	5 638,00 138941 *	5 638,00 138996 *	5 990,00 139047 *
BHTM 12 Bílo hliníková tmavá RAL 9007	5 638,00 138347 *	5 638,00 138392 *	5 990,00 138446 *
Balení v ks 	2	2	2
Balení v ks 	36	36	36

* Výroba na objednávku

TĚSNÍCI GUMA SBĚRNÉHO KOTLÍKA

P-PKLZ T



Jmenovitá velikost	EAN číslo výrobku	Balení v ks		Cena s DPH [CZK/ks]
				
IC 70-85	077103	5	600	132,00
IC 100-110	077110	5	600	136,00
IC 110-125	077097	5	600	139,00
PS 70-85	077134	5	600	146,00
PS 100-110	077141	5	600	161,00
PS 110-125	077127	5	600	166,00

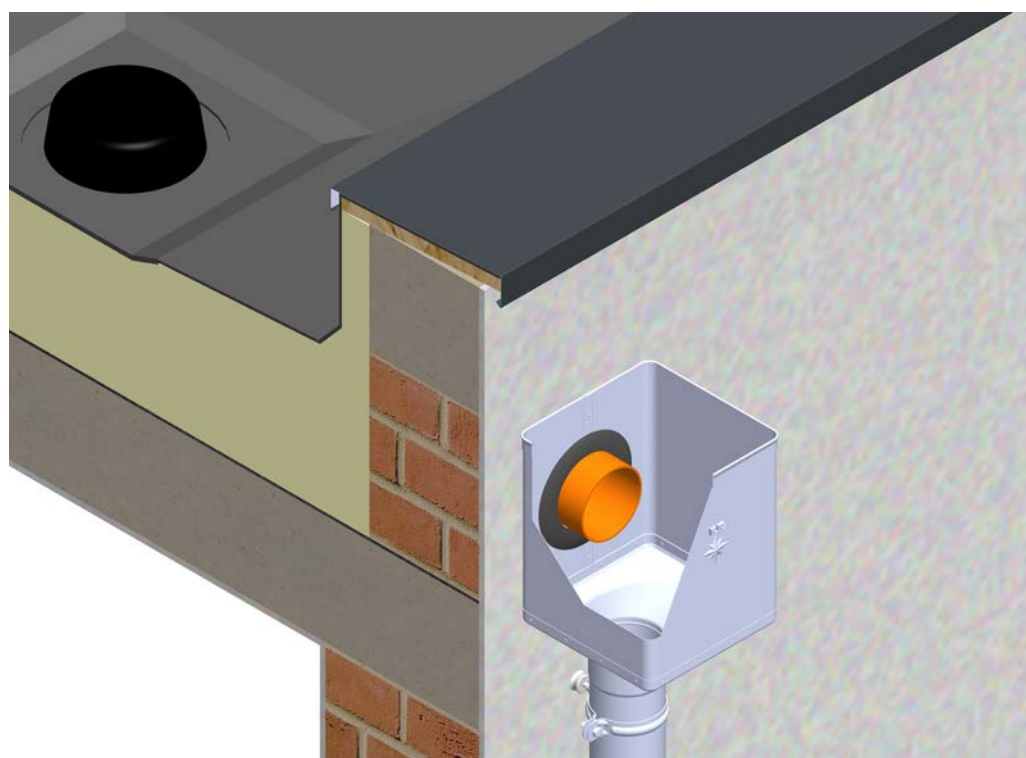

SVODOVÉ KOLENO 72°

W.15-WK



Jmenovitá velikost	80	100	120
Cena v CZK/ks	S DPH	S DPH	S DPH
ANM 1 Antracit RAL 7016	317,00 093523	339,00 093547	515,00 093561
TMM 2 Testa di Moro RAL 8028	317,00 099129	339,00 099136	515,00 099143
SSM 3 Světle šedá RAL 7005	317,00 099099	339,00 099105	515,00 099112
ICM 4 Intenzivní černá RAL 9005	317,00 116567	339,00 116574	515,00 116581 *
OCM 5 Ocelově červená RAL 3009	317,00 116598 *	339,00 116604 *	515,00 116611 *
ZHM 6 Zeleno hnědá RAL 7013	317,00 111517	339,00 111531	515,00 111555
BHM 7 Bílo hliníková RAL 9006	317,00 116536 *	339,00 116543 *	515,00 116550 *
BM 8 Bílá RAL 9010	317,00 135674 *	339,00 135681	515,00 135698 *
ZSM 9 Zinkově šedá RAL extra	317,00 135766 *	339,00 135773 *	515,00 135780 *
MHM 10 Měděno hnědá RAL 8004	317,00 135704	339,00 135711	515,00 135728
MZM 11 Mechově zelená RAL 6005	317,00 135735 *	339,00 135742 *	515,00 135759 *
BHTM 12 Bílo hliníková tmavá RAL 9007	317,00 135643 *	339,00 135650 *	515,00 135667 *
Balení v ks 	4	4	2
Balení v ks 	240	120	120

* Výroba na objednávku



SVODOVÉ KOLENO 85°

W.15-WKR



Jmenovitá velikost	80	100	120
Cena v CZK/ks	S DPH	S DPH	S DPH
ANM 1 Antracit RAL 7016	395,00 093530 *	493,00 093554	634,00 093578 *
TMM 2 Testa di Moro RAL 8028	395,00 099167 *	493,00 099181	634,00 099204 *
SSM 3 Světle šedá RAL 7005	395,00 099150 *	493,00 099174	634,00 099198 *
ICM 4 Intenzivní černá RAL 9005	395,00 116628 *	493,00 116635 *	634,00 116642 *
OCM 5 Ocelově červená RAL 3009	395,00 116659 *	493,00 116666 *	634,00 116673 *
ZHM 6 Zeleno hnědá RAL 7013	395,00 111524 *	493,00 111548	634,00 111562 *
BHM 7 Bílo hliníková RAL 9006	395,00 116680 *	493,00 116697 *	634,00 116703 *
BM 8 Bílá RAL 9010	395,00 136275 *	493,00 136282	634,00 136299 *
ZSM 9 Zinkově šedá RAL extra	395,00 136367 *	493,00 136374 *	634,00 136381 *
MHM 10 Měděno hnědá RAL 8004	395,00 136305 *	493,00 136312 *	634,00 136329 *
MZM 11 Mechově zelená RAL 6005	395,00 136336 *	493,00 136343 *	634,00 136350 *
BHTM 12 Bílo hliníková tmavá RAL 9007	395,00 136224 *	493,00 136251 *	634,00 136268 *
Balení v ks 	4	4	4
Balení v ks 	240	120	120

* Výroba na objednávku



SVODOVÉ KOLENO TUPÉ 40°

W.15-WKT

Jmenovitá velikost	80	100	120
Cena v CZK/ks	S DPH	S DPH	S DPH
ANM 1 Antracit RAL 7016	313,00 093844	388,00 093851	525,00 093868
TMM 2 Testa di Moro RAL 8028	313,00 099440	388,00 099464	525,00 099471 *
SSM 3 Světle šedá RAL 7005	313,00 099433	388,00 099457	525,00 099488 *
ICM 4 Intenzivní černá RAL 9005	313,00 116741 *	388,00 116758 *	525,00 116765 *
OCM 5 Ocelově červená RAL 3009	313,00 116772 *	388,00 116789 *	525,00 116796 *
ZHM 6 Zeleno hnědá RAL 7013	313,00 111814	388,00 111821	525,00 111838 *
BHM 7 Bílo hliníková RAL 9006	313,00 116710 *	388,00 116727 *	525,00 116734 *
BM 8 Bílá RAL 9010	313,00 136428 *	388,00 136435	525,00 136442 *
ZSM 9 Zinkově šedá RAL extra	313,00 136510 *	388,00 136527 *	525,00 136534 *
MHM 10 Měděno hnědá RAL 8004	313,00 136459 *	388,00 136466 *	525,00 136473 *
MZM 11 Mechově zelená RAL 6005	313,00 136480 *	388,00 136497 *	525,00 136503 *
BHTM 12 Bílo hliníková tmavá RAL 9007	313,00 136398 *	388,00 136404 *	525,00 136411 *
Balení v ks 	4	4	4
Balení v ks 	240	120	120

* Výroba na objednávku





ALUMINIUM W.15

MATT 3D EFFECT

SVODOVÁ ROURA [s=0,70]

W.15-WZR





Jmenovitá velikost	80	100	100	120
Délka v m	3,0	3,0	4,0	3,0
Cena v CZK/m	S DPH	S DPH	S DPH	S DPH
ANM Antracit RAL 7016	1 263,00	094131 281,00	094148 281,00	094155 379,00
TMM Testa di Moro RAL 8028	2 263,00	100177 281,00	100184 281,00	100191 379,00
SSM Světle šedá RAL 7005	3 263,00	100139 281,00	100146 281,00	100153 379,00
ICM Intenzivní černá RAL 9005	4 263,00	115294 281,00	115300 281,00	115317 379,00
OCM Ocelově červená RAL 3009	5 263,00	115331 281,00	115348 281,00	115355 379,00
ZHM Zeleno hnědá RAL 7013	6 263,00	112088 281,00	112095 281,00	112101 * 379,00
BHM Bílo hliníková RAL 9006	7 263,00	115249 281,00	115256 281,00	115263 379,00
BM Bílá RAL 9010	8 263,00	132598 281,00	132604 281,00	132611 379,00
ZSM Zinkově šedá RAL extra	9 263,00	132680 * 281,00	132727 * 281,00	132734 * 379,00
MHM Měděno hnědá RAL 8004	10 263,00	132673 * 281,00	132703 * 281,00	132758 * 379,00
MZM Mechově zelená RAL 6005	11 263,00	132697 * 281,00	132710 * 281,00	132741 * 379,00
BHTM Bílo hliníková tmavá RAL 9007	12 263,00	132635 * 281,00	132642 * 281,00	132659 * 379,00
Balení v m 	18	18	24	18
Balení v m 	216	180	240	144

* Výroba na objednávku

PLASTOVÝ SVODOVÝ RUKÁV

SD-ZR FOLIA KJG





Jmenovitá velikost	Délka v m	EAN číslo výrobku	Balení v m		Cena s DPH [CZK/m]
					
60 – 150	100,0	139726	100	6 000	13,00

ALUMINIUM W.15

MATT 3D EFFECT

KOLENO SOKLOVÉ

W.15-WKO

Jmenovitá velikost	80	100	120
Cena v CZK/ks	S DPH	S DPH	S DPH
ANM 1 Antracit RAL 7016	388,00 093813	474,00 093820	562,00 093837
TMM 2 Testa di Moro RAL 8028	388,00 099389 *	474,00 099402 *	562,00 099426 *
SSM 3 Světle šedá RAL 7005	388,00 099372	474,00 099396	562,00 099419 *
ICM 4 Intenzivní černá RAL 9005	388,00 118639 *	474,00 118646	562,00 118653 *
OCM 5 Ocelově červená RAL 3009	388,00 118660 *	474,00 118677 *	562,00 118684 *
ZHM 6 Zeleno hnědá RAL 7013	388,00 111784 *	474,00 111791 *	562,00 111807 *
BHM 7 Bílo hliníková RAL 9006	388,00 118608 *	474,00 118615 *	562,00 118622 *
BM 8 Bílá RAL 9010	388,00 136213 *	474,00 136220	562,00 136237 *
ZSM 9 Zinkově šedá RAL extra	388,00 136152 *	474,00 136169 *	562,00 136176 *
MHM 10 Měděno hnědá RAL 8004	388,00 136091 *	474,00 136107	562,00 136114 *
MZM 11 Mechově zelená RAL 6005	388,00 136121 *	474,00 136138 *	562,00 136145 *
BHTM 12 Bílo hliníková tmavá RAL 9007	388,00 136183 *	474,00 136190 *	562,00 136206 *
Balení v ks 	4	4	2
Balení v ks 	240	120	120



* Výroba na objednávku



SVODOVÁ ODBOČKA 72°

W.15-WZO



Jmenovitá velikost	80/80	100/80	100/100
Cena v CZK/ks	S DPH	S DPH	S DPH
ANM 1 Antracit RAL 7016	1 355,00 094070 *	1 392,00 094087 *	1 406,00 094094
TMM 2 Testa di Moro RAL 8028	1 355,00 100412 *	1 392,00 100429 *	1 406,00 100436 *
SSM 3 Světle šedá RAL 7005	1 355,00 100351 *	1 392,00 100368 *	1 406,00 100375 *
ICM 4 Intenzivní černá RAL 9005	1 355,00 119018 *	1 392,00 119049 *	1 406,00 119087 *
OCM 5 Ocelově červená RAL 3009	1 355,00 119025 *	1 392,00 119063 *	1 406,00 119094 *
ZHM 6 Zeleno hnědá RAL 7013	1 355,00 112026 *	1 392,00 112033 *	1 406,00 112040 *
BHM 7 Bílo hliníková RAL 9006	1 355,00 119032 *	1 392,00 119056 *	1 406,00 119070 *
BM 8 Bílá RAL 9010	1 355,00 137258 *	1 392,00 157265 *	1 406,00 137272 *
ZSM 9 Zinkově šedá RAL extra	1 355,00 137432 *	1 392,00 137449 *	1 406,00 137456 *
MHM 10 Měděno hnědá RAL 8004	1 355,00 137319 *	1 392,00 137326 *	1 406,00 137333 *
MZM 11 Mechově zelená RAL 6005	1 355,00 137371 *	1 392,00 137388 *	1 406,00 137395 *
BHTM 12 Bílo hliníková tmavá RAL 9007	1 355,00 137197 *	1 392,00 137203 *	1 406,00 137210 *
Balení v ks 	4	4	4
Balení v ks 	120	120	120



* Výroba na objednávku

ALUMINIUM W.15

MATT 3D EFFECT

SVODOVÁ ODBOČKA 72°

W.15-WZO



Jmenovitá velikost	120/80	120/100	120/120
Cena v CZK/ks	S DPH	S DPH	S DPH
ANM 1 Antracit RAL 7016	1 518,00 094100 *	1 535,00 094117 *	1 545,00 094124 *
TMM 2 Testa di Moro RAL 8028	1 518,00 100443 *	1 535,00 100450 *	1 545,00 100467 *
SSM 3 Světle šedá RAL 7005	1 518,00 100382 *	1 535,00 100399 *	1 545,00 100405 *
ICM 4 Intenzivní černá RAL 9005	1 518,00 119117 *	1 535,00 119148 *	1 545,00 119179 *
OCM 5 Ocelově červená RAL 3009	1 518,00 119100 *	1 535,00 119155 *	1 545,00 119186 *
ZHM 6 Zeleno hnědá RAL 7013	1 518,00 112057 *	1 535,00 112064 *	1 545,00 112071 *
BHM 7 Bílo hliníková RAL 9006	1 518,00 119124 *	1 535,00 119131 *	1 545,00 119162 *
BM 8 Bílá RAL 9010	1 518,00 137289 *	1 535,00 137296 *	1 545,00 137302 *
ZSM 9 Zinkově šedá RAL extra	1 518,00 137463 *	1 535,00 137470 *	1 545,00 137487 *
MHM 10 Měděno hnědá RAL 8004	1 518,00 137340 *	1 535,00 137357 *	1 545,00 137364 *
MZM 11 Mechově zelená RAL 6005	1 518,00 137401 *	1 535,00 137418 *	1 545,00 137425 *
BHTM 12 Bílo hliníková tmavá RAL 9007	1 518,00 137227 *	1 535,00 137234 *	1 545,00 137241 *
Balení v ks 	3	3	3
Balení v ks 	90	90	90

* Výroba na objednávku



SVODOVÁ OBJÍMKA M10

W.15-WOB

Jmenovitá velikost	80	100	120
Cena v CZK/ks	S DPH	S DPH	S DPH
ANM 1 Antracit RAL 7016	115,00 093875	120,00 093882	137,00 093899
TMM 2 Testa di Moro RAL 8028	115,00 099761	120,00 099778	137,00 099785
SSM 3 Světle šedá RAL 7005	115,00 099730	120,00 099747	137,00 099754
ICM 4 Intenzivní černá RAL 9005	115,00 118530	120,00 118547	137,00 118554 *
OCM 5 Ocelově červená RAL 3009	115,00 118561 *	120,00 118578 *	137,00 118585 *
ZHM 6 Zeleno hnědá RAL 7013	115,00 111845	120,00 111852	137,00 111869
BHM 7 Bílo hliníková RAL 9006	115,00 118509 *	120,00 118516 *	137,00 118523 *
BM 8 Bílá RAL 9010	115,00 136572 *	120,00 136589	137,00 136596 *
ZSM 9 Zinkově šedá RAL extra	115,00 136664 *	120,00 136671 *	137,00 136688 *
MHM 10 Měděno hnědá RAL 8004	115,00 136602	120,00 136619	137,00 136626
MZM 11 Mechově zelená RAL 6005	115,00 136633 *	120,00 136640 *	137,00 136657 *
BHTM 12 Bílo hliníková tmavá RAL 9007	115,00 136541 *	120,00 136558 *	137,00 136565 *
Balení v ks 	10	10	10
Balení v ks 	1 200	1 200	1 200

* Výroba na objednávku





ALUMINIUM W.15

MATT 3D EFFECT

NEREZOVÝ ŠROUB PRO OBJÍMKY M8x30

P-POB-NSK





Jmenovitá velikost	EAN číslo výrobku	Balení v ks		Cena s DPH [CZK/ks]
				
M8 x 30 *	139658	1	–	9,00

* Výroba na objednávku

ŠROUB PRO OBJÍMKU SE ZÁVITOVOU MATKOU TORX M10

P-POB-HT





Jmenovitá velikost	EAN číslo výrobku	Balení v ks		Cena s DPH [CZK/ks]
				
80	002464	100	40 000	26,00
140	002471	100	28 000	35,00
200	002488	100	20 000	44,00
250	002495	100	16 000	50,00
300	002501	100	11 200	51,00

HMOŽDINKA BEZ LAMELY M10

P-POB-HN DB





Jmenovitá velikost	EAN číslo výrobku	Balení v ks		Cena s DPH [CZK/ks]
				
120	002426	100	25 000	13,00

HMOŽDINKA S LAMELOU M10

P-POB-HN DB





Jmenovitá velikost	EAN číslo výrobku	Balení v ks		Cena s DPH [CZK/ks]
				
180	002433	100	12 000	13,00
240	002440	100	12 000	15,00
280	002457	100	12 000	16,00

KOMBISKRUTKA TORX M10

P-POB-ZT/SZ



Jmenovitá velikost	EAN číslo výrobku	Balení v ks		Cena s DPH [CZK/ks]
				
140	002587	50	10 400	15,00
180	002594	50	10 400	19,00



ALUMINIUM W.15

MATT 3D EFFECT

IZOLAČNÍ HMOŽDINKA M10

P-POB-HN IZOL





Jmenovitá velikost	EAN číslo výrobku	Balení v ks		Cena s DPH [CZK/ks]
				
M10 x 96	001207	25	2 625	165,00

ZÁVITOVÁ TYČ M10

P-POB-ZT





Jmenovitá velikost	EAN číslo výrobku	Balení v ks		Cena s DPH [CZK/ks]
				
60	002556	100	20 800	7,00
100	002563	100	15 600	11,00
150	002570	50	10 400	19,00

MONTÁŽNÍ PLATNA M10

P-POB-ZT MP













Jmenovitá velikost	EAN číslo výrobku	Balení v ks		Cena s DPH [CZK/ks]
				
80 x 30	002518	25	5 200	39,00

KRYTKA PRO ŠROUB OBJÍMKY



P-POB-HT AKG



Jmenovitá velikost	EAN číslo výrobku	Balení v ks		Cena s DPH [CZK/ks]
				
 29 x 13	002280	50	16 800	8,00
 29 x 13	002211	50	16 800	8,00
 29 x 13	002235	50	16 800	8,00
 29 x 13	002266	50	16 800	8,00
 29 x 13	002242	50	16 800	8,00
 29 x 13	002228	50	16 800	8,00
 29 x 13	002273	50	16 800	8,00
 29 x 13	002259	50	16 800	8,00
 29 x 13	002297	50	16 800	8,00

DEŠŤOVÁ KLAPKA S LAPAČEM LISTÍ

W.15-WZVS

Jmenovitá velikost	80	100	120
Cena v CZK/ks	S DPH	S DPH	S DPH
ANM 1 Antracit RAL 7016	898,00 094216	986,00 094223	1 481,00 094230
TMM 2 Testa di Moro RAL 8028	898,00 100320	986,00 100337	1 481,00 100344
SSM 3 Světle šedá RAL 7005	898,00 100290	986,00 100306	1 481,00 100313
ICM 4 Intenzivní černá RAL 9005	898,00 114419	986,00 114426	1 481,00 114433
OCM 5 Ocelově červená RAL 3009	898,00 114389 *	986,00 114402 *	1 481,00 114396 *
ZHM 6 Zeleno hnědá RAL 7013	898,00 112156	986,00 112163	1 481,00 112170
BHM 7 Bílo hliníková RAL 9006	898,00 114440	986,00 114457	1 481,00 114464
BM 8 Bílá RAL 9010	898,00 124883 *	986,00 124890	1 481,00 124906 *
ZSM 9 Zinkově šedá RAL extra	898,00 124975 *	986,00 124982 *	1 481,00 124999 *
MHM 10 Měděno hnědá RAL 8004	898,00 124913 *	986,00 124920 *	1 481,00 124937 *
MZM 11 Mechově zelená RAL 6005	898,00 124944 *	986,00 124951 *	1 481,00 124968 *
BHTM 12 Bílo hliníková tmavá RAL 9007	898,00 124852 *	986,00 124869 *	1 481,00 124876 *
Balení v ks 	2	3	3
Balení v ks 	240	90	90



* Výroba na objednávku



SBĚRAČ DEŠŤOVÉ VODY S HADICÍ

W.15-WZVHA





Jmenovitá velikost	80	100	120
Cena v CZK/ks	S DPH	S DPH	S DPH
ANM 1 Antracit RAL 7016	2 290,00 094186 *	2 290,00 094193	4 404,00 094209 *
TMM 2 Testa di Moro RAL 8028	2 290,00 100269 *	2 290,00 100276 *	4 404,00 100283 *
SSM 3 Světle šedá RAL 7005	2 290,00 100238 *	2 290,00 100245 *	4 404,00 100252 *
ICM 4 Intenzivní černá RAL 9005	2 290,00 116116 *	2 290,00 116123 *	4 404,00 116130 *
OCM 5 Ocelově červená RAL 3009	2 290,00 116147 *	2 290,00 116154 *	4 404,00 116161 *
ZHM 6 Zeleno hnědá RAL 7013	2 290,00 112132 *	2 290,00 112316 *	4 404,00 112149 *
BHM 7 Bílo hliníková RAL 9006	2 290,00 116086 *	2 290,00 116093 *	4 404,00 116109 *
BM 8 Bílá RAL 9010	2 290,00 137623 *	2 290,00 137630 *	4 404,00 137647 *
ZSM 9 Zinkově šedá RAL extra	2 290,00 137715 *	2 290,00 137722 *	4 404,00 137739 *
MHM 10 Měděno hnědá RAL 8004	2 290,00 137654 *	2 290,00 137661 *	4 404,00 137678 *
MZM 11 Mechově zelená RAL 6005	2 290,00 137685 *	2 290,00 137692 *	4 404,00 137708 *
BHTM 12 Bílo hliníková tmavá RAL 9007	2 290,00 137593 *	2 290,00 137609 *	4 404,00 137616 *
Balení v ks 	1	1	1
Balení v ks 	60	60	60

* Výroba na objednávku

ALUMINIUM W.15

MATT 3D EFFECT

POZINKOVANÝ SVOD OCHRANNÝ S REVIZNÍM OTVOREM W.15-WOZR

Jmenovitá velikost	80	100	100
Délka v m	1,0	1,0	1,5
Cena v CZK/ks	S DPH	S DPH	S DPH
ANM Antracit RAL 7016	2 219,00 122742 *	1 728,00 122759 *	3 524,00 122766 *
TMM Testa di Moro RAL 8028	2 219,00 123046 *	1 728,00 123053 *	3 524,00 123060 *
SSM Světle šedá RAL 7005	2 219,00 122995 *	1 728,00 123008 *	3 524,00 123015 *
ICM Intenzivní černá RAL 9005	2 219,00 122797 *	1 728,00 122803 *	3 524,00 122810 *
OCM Ocelově červená RAL 3009	2 219,00 122841 *	1 728,00 122858 *	3 524,00 122865 *
ZHM Zeleno hnědá RAL 7013	2 219,00 122940 *	1 728,00 122957 *	3 524,00 122964 *
BHM Bílo hliníková RAL 9006	2 219,00 122896 *	1 728,00 122902 *	3 524,00 122919 *
BM Bílá RAL 9010	2 219,00 123190 *	1 728,00 123206 *	3 524,00 123213 *
ZSM Zinkově šedá RAL extra	2 219,00 123145 *	1 728,00 123152 *	3 524,00 123169 *
MHM Měděno hnědá RAL 8004	2 219,00 123244 *	1 728,00 123251 *	3 524,00 123268 *
MZM Mechově zelená RAL 6005	2 219,00 123091 *	1 728,00 123107 *	3 524,00 123114 *
BHTM Bílo hliníková tmavá RAL 9007	2 219,00 123336 *	1 728,00 123305 *	3 524,00 123312 *
Balení v ks 	1	1	1
Balení v ks 	70	60	60

* Výroba na objednávku





ALUMINIUM W.15

MATT 3D EFFECT

POZINKOVANÝ SVOD OCHRANNÝ S REVIZNÍM OTVOREM W.15-WOZR





Jmenovitá velikost	120	120
Délka v m	1,0	1,5
Cena v CZK/ks	S DPH	S DPH
ANM Antracit RAL 7016	1 3 876,00 122773 *	5 533,00 122780 *
TMM Testa di Moro RAL 8028	2 3 876,00 123077 *	5 533,00 123084 *
SSM Světle šedá RAL 7005	3 3 876,00 123022 *	5 533,00 123039 *
ICM Intenzivní černá RAL 9005	4 3 876,00 122827 *	5 533,00 122834 *
OCM Ocelově červená RAL 3009	5 3 876,00 122872 *	5 533,00 122889 *
ZHM Zeleno hnědá RAL 7013	6 3 876,00 122971 *	5 533,00 122988 *
BHM Bílo hliníková RAL 9006	7 3 876,00 122926 *	5 533,00 122933 *
BM Bílá RAL 9010	8 3 876,00 123220 *	5 533,00 123237 *
ZSM Zinkově šedá RAL extra	9 3 876,00 123176 *	5 533,00 123183 *
MHM Měděno hnědá RAL 8004	10 3 876,00 123275 *	5 533,00 123282 *
MZM Mechově zelená RAL 6005	11 3 876,00 123121 *	5 533,00 123138 *
BHTM Bílo hliníková tmavá RAL 9007	12 3 876,00 123329 *	5 533,00 123299 *
Balení v ks 	1	1
Balení v ks 	40	40

* Výroba na objednávku

POZINKOVANÁ OBJÍMKA S GUMOU M10

P-POB-OZR



Jmenovitá velikost	EAN číslo výrobku	Balení v ks		Cena s DPH [CZK/ks]
				
80	002525	25	1 250	54,00
100	002532	25	1 250	68,00
120	002549	20	1 000	77,00

