



OKAPOVÝ SYSTÉM PŮLKRUHOVÝ



CENÍK
2023

DOPORUČENÉ SPOTŘEBITELSKÉ CENY



POWERFUL PARTNER FOR YOUR ROOF



Pozink
materiál | 3



Žlab | 6



Žlabová
dilatace | 12



Žlab
příslušenství | 15



Žlabový
hák | 19



Roh | 24



Čelo
žlabové | 26



Kotlík
žlabový | 28



Koleno | 40



Svodová
roura | 45



Svodová roura
příslušenství | 52



Objímka | 55



Objímka
příslušenství | 59



Dešťová
klapka | 62



Svod
ochranný | 65

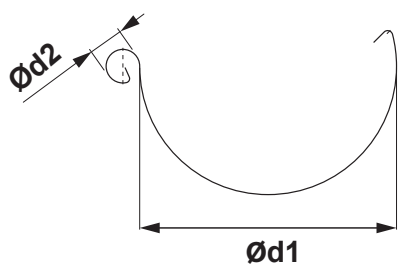

ROZMĚRY STŘEŠNÍCH ŽLABŮ

(rozměry a rozměrové tolerance podle EN 612)

Rozvinutá šířka (mm)	200	250	280	333	400	500
Ød1	80	105	127	153	192	250
Ød2	16	18	18	20	22	22

VNITŘNÍ FALC

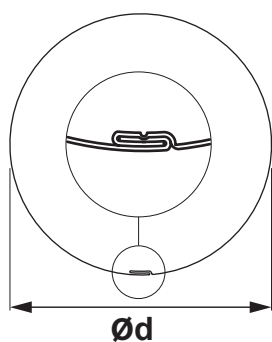

ROZMĚRY STŘEŠNÍCH SVODŮ

(rozměry a rozměrové tolerance podle EN 612)

Rozměry	60	80	100	120	150
Jmenovitá velikost Ød (mm)	60	80	100	120	150

ROZMĚRY STŘEŠNÍCH HÁKŮ

(rozměry a rozměrové tolerance podle EN 612)

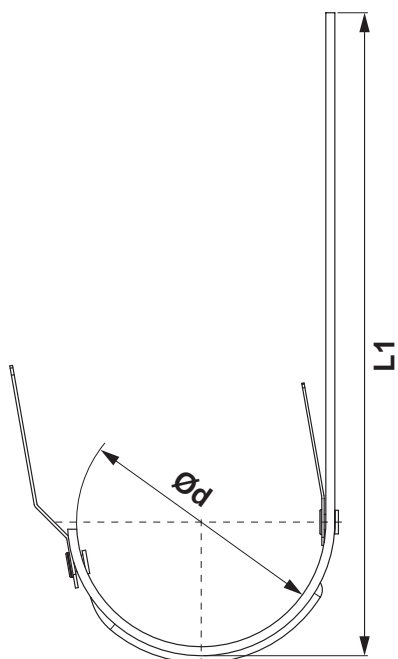

Rozměry (mm)	L1	Ød
200	290	80
250	310	105
280	345	127
333 – 550	385	153
333 – 610	445	153
400	400	192

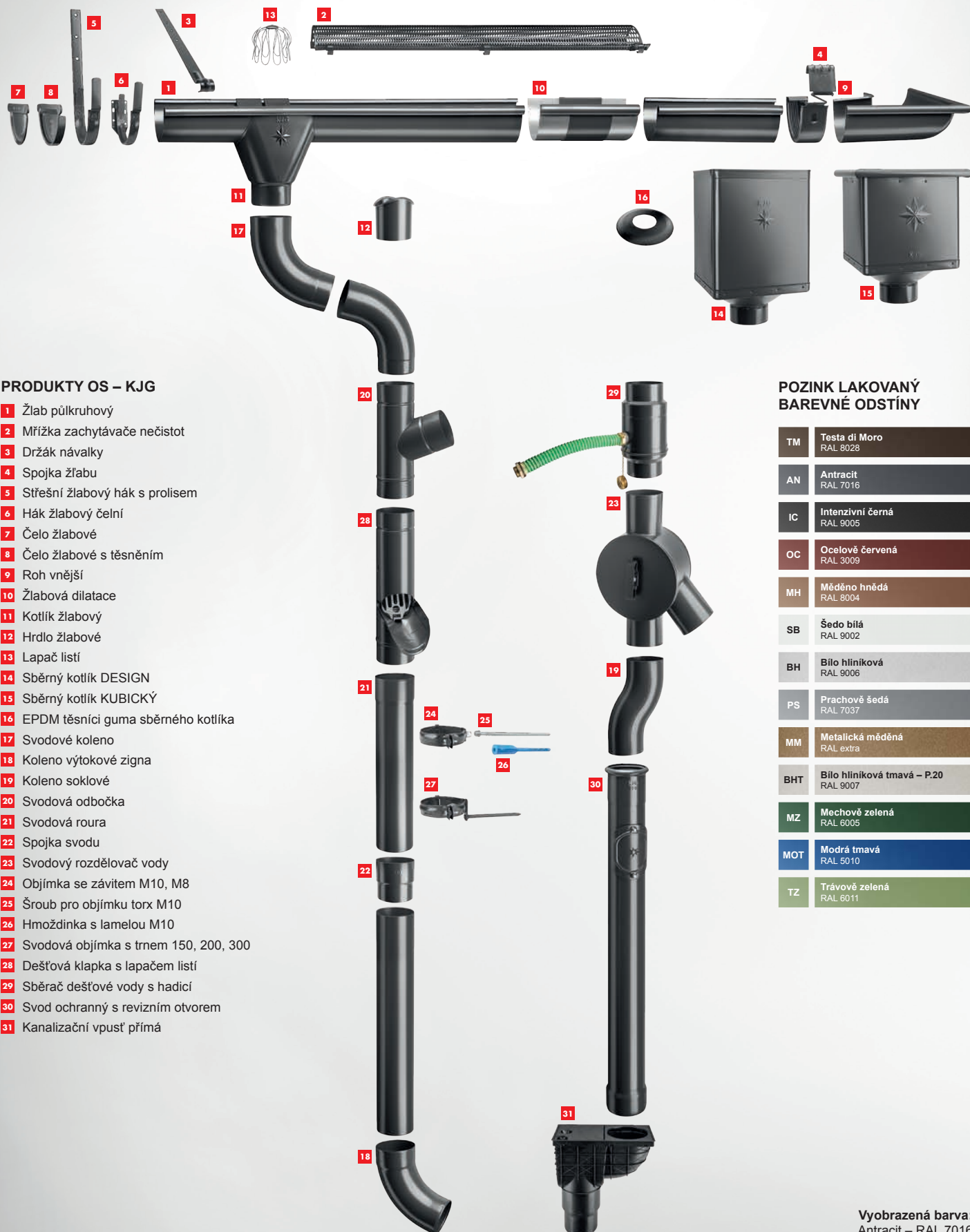

PRODUKTY OS – KJG

- 1 Žlab půlkruhový
- 2 Mřížka zachytávače nečistot
- 3 Držák návalky
- 4 Spojka žlabu
- 5 Střešní žlabový hák s prolisem
- 6 Háček žlabový čelní
- 7 Čelo žlabové
- 8 Čelo žlabové s těsněním
- 9 Roh vnější
- 10 Žlabová dilatace
- 11 Kotlík žlabový
- 12 Hrdlo žlabové
- 13 Lapač listí
- 14 Sběrný kotlík DESIGN
- 15 Sběrný kotlík KUBICKÝ
- 16 EPDM těsnící guma sběrného kotlíka
- 17 Svodové koleno
- 18 Koleno výtokové zigna
- 19 Koleno soklové
- 20 Svodová odbočka
- 21 Svodová roura
- 22 Spojka svodu
- 23 Svodový rozdělovač vody
- 24 Objímka se závitem M10, M8
- 25 Šroub pro objímku torx M10
- 26 Hmoždinka s lamelou M10
- 27 Svodová objímka s trnem 150, 200, 300
- 28 Dešťová klapka s lapačem listí
- 29 Sběrač dešťové vody s hadicí
- 30 Svod ochranný s revizním otvorem
- 31 Kanalizační vpust' přímá

POZINK LAKOVANÝ BAREVNÉ ODSTÍNY

TM	Testa di Moro RAL 8028
AN	Antracit RAL 7016
IC	Intenzivní černá RAL 9005
OC	Ocelově červená RAL 3009
MH	Měděno hnědá RAL 8004
SB	Šedo bílá RAL 9002
BH	Bílo hliníková RAL 9006
PS	Prachově šedá RAL 7037
MM	Metalická měděná RAL extra
BHT	Bílo hliníková tmavá – P.20 RAL 9007
MZ	Mechově zelená RAL 6005
MOT	Modrá tmavá RAL 5010
TZ	Trávnově zelená RAL 6011

TATA STEEL





Společnost Tata byla založena v roce 1868 společností Jamsetji Nusserwanji Tata a má sídlo v Indii. Je to globální obchodní konglomerát, který působí ve více než 100 zemích na pěti kontinentech. Od raného nástupu do oceli a automobilů, aby držela krok s nejnovějšími technologiemi, má dnes skupina Tata silnou pozici v různých odvětvích, jako jsou agrochemikálie, automobilový průmysl, chemikálie, stavebnictví, finance a spotřební výrobky.

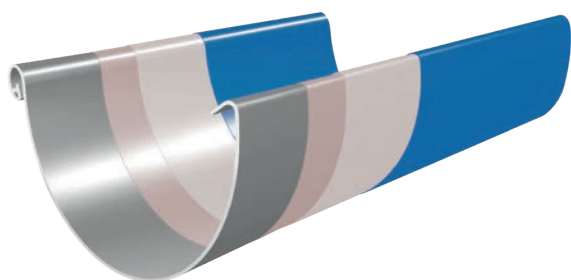

MARCEGAGLIA



Marcegaglia je vedoucí hráč v Itálii a největší nezávislý globální operátor v ocelářském průmyslu. Marcegaglia zpracovává každý rok 5,6 milionu tun a dosahující obrát více než 5 miliard eur (2017) je italská průmyslová skupina, která je významným hráčem v Evropě a na celém světě v oblasti transformace oceli. Získané vedení je výsledkem dlouhé, pevné a stabilní růstové cesty, díky níž je Marcegaglia největším nezávislým globálním hráčem v oblasti transformace oceli.



-  Vrchní lakovaná vrstva (cca 20 μm) na polyesterové bázi pro výbornou optiku a nejvyšší odolnost vůči poškození
-  Primer (cca 5 μm) pro perfektní přilnavost a pevnou antikorozi ochranu
-  Zinková vrstva (225 g/m²) pro trvalou antikorozi ochranu
-  Optimalizovaný ocelový pás pro okapový systém OS – KJG

ŽLAB PŮLKRUHOVÝ [s=0,55]

P-PZ

Jmenovitá velikost	200	200	200
Délka v m	2,0	3,0	4,0
Cena v CZK/m	S DPH	S DPH	S DPH
TM Testa di Moro RAL 8028	1 235,00 043610	235,00 043627	235,00 043634
AN Antracit RAL 7016	2 235,00 042187	235,00 042194	235,00 042200
IC Intenzivní černá RAL 9005	3 235,00 042545	235,00 042552	235,00 042569
OC Ocelově červená RAL 3009	4	235,00 043191	235,00 043207
MH Měděno hnědá RAL 8004	5	239,00 042750	
SB Šedo bílá RAL 9002	6	239,00 043498	
BH Bílo hliníková RAL 9006	7	239,00 042392	239,00 042408
PS Prachově šedá RAL 7037	8	239,00 043375	239,00 043382
MM Metalická měděná RAL extra	9	254,00 042927	
BHT – P.20 Bílo hliníková tmavá RAL 9007	10		
MZ Mechově zelená RAL 6005	11	254,00 043085	
MOT Modrá tmavá RAL 5010	12	254,00 043016 *	
TZ Trávově zelená RAL 6011	13	254,00 043825 *	
Balení v m 	10	15	20
Balení v m 	800	1 200	1 600

* Výroba na objednávku

POZINK
POLYESTER



ŽLAB PŮLKRUHOVÝ [s=0,55]

P-PZ

Jmenovitá velikost	250	250	250	250	250
Délka v m	2,0	3,0	4,0	5,0	6,0
Cena v CZK/m	S DPH	S DPH	S DPH	S DPH	S DPH
TM Testa di Moro RAL 8028	1 210,00	205,00	205,00	205,00	205,00
	043641	043658	043665	043672	043689
AN Antracit RAL 7016	2 210,00	205,00	205,00	205,00	205,00
	042217	042224	042231	042248	042255
IC Intenzivní černá RAL 9005	3 210,00	205,00	205,00	205,00	205,00
	042576	042583	042590	042606	042613
OC Ocelově červená RAL 3009	4 210,00	205,00	205,00	205,00	205,00
	043214	043221	043238	043245	043252
MH Měděno hnědá RAL 8004	5 213,00	208,00	208,00	208,00	208,00
	042774	042781	042798	042804	042811
SB Šedo bílá RAL 9002	6	208,00	208,00		208,00
		043504	043511		043528
BH Bílo hliníková RAL 9006	7	208,00	208,00	208,00	208,00
		042415	042422	042439	042446
PS Prachově šedá RAL 7037	8		208,00		208,00
			043399		043405
MM Metalická měděná RAL extra	9		220,00		220,00
			042934		042941
BHT – P.20 Bílo hliníková tmavá RAL 9007	10		254,00		
			095466		
MZ Mechově zelená RAL 6005	11		220,00		220,00
			043092		043108
MOT Modrá tmavá RAL 5010	12		220,00		
			043023		
TZ Trávově zelená RAL 6011	13		220,00		
			043832		
Balení v m 	10	15	20	25	30
Balení v m 	480	720	960	1 200	1 440



ŽLAB PŮLKRUHOVÝ [s=0,55]

P-PZ

Jmenovitá velikost	280	280	280	280	280
Délka v m	2,0	3,0	4,0	5,0	6,0
Cena v CZK/m	S DPH	S DPH	S DPH	S DPH	S DPH
TM Testa di Moro RAL 8028	1 237,00	232,00	232,00	232,00	232,00
	043696	043702	043719	043726	043733
AN Antracit RAL 7016	2 237,00	232,00	232,00	232,00	232,00
	042262	042279	042286	042293	042309
IC Intenzivní černá RAL 9005	3 237,00	232,00	232,00	232,00	232,00
	042620	042637	042644	042651	042668
OC Ocelově červená RAL 3009	4	232,00	232,00	232,00	232,00
		043269	043276	043283	043290
MH Měděno hnědá RAL 8004	5	235,00	235,00		235,00
		042828	042835		042842
SB Šedo bílá RAL 9002	6		235,00		235,00
			043535		043542
BH Bílo hliníková RAL 9006	7	235,00	235,00		235,00
		042453	042460		042477
PS Prachově šedá RAL 7037	8		235,00		235,00
			043412		043429
MM Metalická měděná RAL extra	9		252,00		252,00
			042958		042965
BHT – P.20 Bílo hliníková tmavá RAL 9007	10		285,00		
			095473		
MZ Mechově zelená RAL 6005	11		252,00		252,00
			043115		043122
MOT Modrá tmavá RAL 5010	12		252,00		
			043030		
TZ Trávově zelená RAL 6011	13		252,00		
			043849		
Balení v m 	10	15	20	25	30
Balení v m 	420	630	840	1 050	1 260

POZINK
POLYESTER



ŽLAB PŮLKRUHOVÝ [s=0,55]

P-PZ

Jmenovitá velikost	333	333	333	333	333
Délka v m	2,0	3,0	4,0	5,0	6,0
Cena v CZK/m	S DPH	S DPH	S DPH	S DPH	S DPH
TM Testa di Moro RAL 8028	1 247,00	241,00	241,00	241,00	241,00
	043740	043757	043764	043771	043788
AN Antracit RAL 7016	2 247,00	241,00	241,00	241,00	241,00
	042316	042323	042330	042347	042354
IC Intenzivní černá RAL 9005	3 247,00	241,00	241,00	241,00	241,00
	042675	042682	042699	042705	042712
OC Ocelově červená RAL 3009	4 247,00	241,00	241,00	241,00	241,00
	043306	043313	043320	043337	043344
MH Měděno hnědá RAL 8004	5 251,00	244,00	244,00	244,00	244,00
	042859	042866	042873	042880	042897
SB Šedo bílá RAL 9002	6	244,00	244,00	244,00	244,00
		043559	043566	043573	043580
BH Bílo hliníková RAL 9006	7	244,00	244,00	244,00	244,00
		042484	042491	042507	042514
PS Prachově šedá RAL 7037	8	244,00	244,00	244,00	244,00
		043436	043443	043450	043467
MM Metalická měděná RAL extra	9		281,00	281,00	281,00
			042972	042989	042996
BHT – P.20 Bílo hliníková tmavá RAL 9007	10		288,00		288,00
			095480		095497
MZ Mechově zelená RAL 6005	11		281,00	281,00	281,00
			043139	043146	043153
MOT Modrá tmavá RAL 5010	12		281,00		281,00
			043047		043054
TZ Trávově zelená RAL 6011	13		281,00		
			043856		
Balení v m 📦	10	15	20	25	30
Balení v m 🚚	330	495	660	825	990



ŽLAB PŮLKRUHOVÝ [s=0,55]



P-PZ

Jmenovitá velikost	400	400	500	500	333
Délka v m	4,0	6,0	4,0	6,0	7,0
Cena v CZK/m	S DPH	S DPH	S DPH	S DPH	S DPH
TM 1 Testa di Moro RAL 8028	388,00	388,00			241,00
	043801	043818			043795 *
AN 2 Antracit RAL 7016	388,00	388,00	525,00	525,00	
	042361	042378	086730 *	086747 *	
IC 3 Intenzivní černá RAL 9005	388,00	388,00			
	042729	042736			
OC 4 Ocelově červená RAL 3009	388,00	388,00			
	043351	043368			
MH 5 Měděno hnědá RAL 8004	391,00	391,00			
	042903	042910			
SB 6 Šedo bílá RAL 9002	391,00	391,00	529,00	529,00	
	043597	043603	086778 *	086785 *	
BH 7 Bílo hliníková RAL 9006	391,00	391,00	529,00	529,00	
	042521	042538	086754 *	086761 *	
PS 8 Prachově šedá RAL 7037	391,00	391,00			
	043474	043481			
MM 9 Metalická měděná RAL extra	412,00				
	043009				
BHT – P.20 10 Bílo hliníková tmavá RAL 9007		434,00			
		095503			
MZ 11 Mechově zelená RAL 6005	412,00	412,00			
	043160	043177 *			
MOT 12 Modrá tmavá RAL 5010	412,00	412,00			
	043061	043078			
TZ 13 Trávově zelená RAL 6011	412,00				
	043863 *				
Balení v m 	20	30	20	30	35
Balení v m 	540	810	–	–	1 155

* Výroba na objednávku



ŽLAB NÁSTŘEŠNÍ [s=0,55]
P-PZS

Jmenovitá velikost	650	650
Délka v m	4,0	6,0
Cena v CZK/m	S DPH	S DPH
TM 1 Testa di Moro RAL 8028	745,00 049926	745,00 049933
AN 2 Antracit RAL 7016	745,00 049759	745,00 049766
IC 3 Intenzivní černá RAL 9005	745,00 049797	745,00 049803
OC 4 Ocelově červená RAL 3009	745,00 049865	745,00 049872
MH 5 Měděno hnědá RAL 8004	772,00 049810	772,00 049827
SB 6 Šedo bílá RAL 9002	772,00 049902	
BH 7 Bílo hliníková RAL 9006	772,00 049773	772,00 049780
PS 8 Prachově šedá RAL 7037	772,00 049889	
MM 9 Metalická měděná RAL extra	854,00 049834	
BHT – P.20 10 Bílo hliníková tmavá RAL 9007	991,00 095749 *	
MZ 11 Mechově zelená RAL 6005	854,00 049858	
MOT 12 Modrá tmavá RAL 5010	854,00 049841 *	
TZ 13 Trávnově zelená RAL 6011	854,00 049940 *	
Balení v m 	4	6
Balení v m 	200	300

* Výroba na objednávku



ŽLABOVÁ DILATACE

P-PZDI

Jmenovitá velikost	250/260	280/260	333/260	400/260
Cena v CZK/ks	S DPH	S DPH	S DPH	S DPH
TM 1 Testa di Moro RAL 8028	495,00 013064	525,00 013071	573,00 013088	674,00 013095
AN 2 Antracit RAL 7016	495,00 012661	525,00 012678	573,00 012685	674,00 012692
IC 3 Intenzivní černá RAL 9005	495,00 012746 *	525,00 012753 *	573,00 012760	674,00 012777 *
OC 4 Ocelově červená RAL 3009	495,00 012944 *	525,00 012951 *	573,00 012968 *	674,00 012975 *
MH 5 Méděno hnědá RAL 8004	495,00 012784 *	525,00 012791 *	573,00 012807 *	674,00 012814 *
SB 6 Šedo bílá RAL 9002	495,00 013026 *	525,00 013033 *	573,00 013040 *	674,00 013057 *
BH 7 Bílo hliníková RAL 9006	495,00 012708 *	525,00 012715 *	573,00 012722 *	674,00 012739 *
PS 8 Prachově šedá RAL 7037	495,00 012982 *	525,00 012999 *	573,00 013002 *	674,00 013019 *
MM 9 Metalická měděná RAL extra	495,00 012821 *	525,00 012838 *	573,00 012845 *	674,00 012852 *
BHT – P.20 10 Bílo hliníková tmavá RAL 9007	495,00 096098 *	525,00 096104 *	573,00 096111 *	674,00 114044 *
MZ 11 Mechově zelená RAL 6005	495,00 012906 *	525,00 012913 *	573,00 012920 *	674,00 012937 *
MOT 12 Modrá tmavá RAL 5010	495,00 012869 *	525,00 012876 *	573,00 012883 *	674,00 012890 *
TZ 13 Trávnově zelená RAL 6011	495,00 013101 *	525,00 013118 *	573,00 013125 *	674,00 013132 *
Balení v ks 	3	3	5	5
Balení v ks 	360	360	200	200

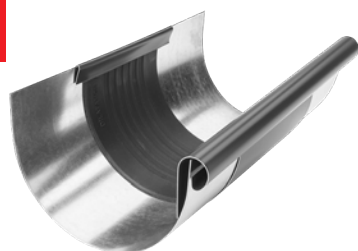

* Výroba na objednávku



DILATACE NÁSTŘEŠNÍHO ŽLABU

P-PZSDI





Jmenovitá velikost	670/260	
Cena v CZK/ks	S DPH	
TM 1 Testa di Moro RAL 8028	1 067,00	013637 *
AN 2 Antracit RAL 7016	1 067,00	013545 *
IC 3 Intenzivní černá RAL 9005	1 067,00	013569 *
OC 4 Ocelově červená RAL 3009	1 067,00	013606 *
MH 5 Měděno hnědá RAL 8004	1 067,00	013576 *
SB 6 Šedo bílá RAL 9002	1 067,00	013620 *
BH 7 Bílo hliníková RAL 9006	1 067,00	013552 *
PS 8 Prachově šedá RAL 7037	1 067,00	013613 *
MM 9 Metalická měděná RAL extra	1 067,00	013583 *
BHT – P.20 10 Bílo hliníková tmavá RAL 9007	1 067,00	096067 *
MZ 11 Mechově zelená RAL 6005	1 067,00	013651 *
MOT 12 Modrá tmavá RAL 5010	1 067,00	013590 *
TZ 13 Trávově zelená RAL 6011	1 067,00	013644 *
Balení v ks 	1	
Balení v ks 	40	

* Výroba na objednávku

DILATAČNÍ PÁS

P-PZDIP



Jmenovitá velikost	Délka v m	EAN číslo výrobku	Balení v m		Cena s DPH [CZK/m]
					
260	3,0	012470	3	120	1 138,00
260	6,0	012487	6	240	1 138,00

POUŽITÍ DILATAČNÍHO ŽLABU A PÁSOVÉ DILATACE

DILATAČNÍ ŽLAB

Příklad montáže: Podokapový žlab o rozvinuté šířce do 500 mm. Dilatační žlab musí být namontován v rozestupu 15 m. Pro vnější roh a začátek žlabu platí polovina standardní hodnoty: maximálně 7,5 m. Pro vnitřní roh platí čtvrtina standardní hodnoty: maximálně 3,75 m. Pro ostatní materiály a rozměry: viz tabulka níže. Rohy se vždy počítají jako pevné body.

STŘEŠNÍ PŮLKRUHOVÉ DILATAČNÍ ŽLABY

Rozvinutá šířka žlabu	Hliník	Pozink, Titan-zinek, Měď, Nerez
< 500	12	15
> 500	8	10

PÁSOVÁ DILATACE

Vnitřní instalace: na žlaby uchycené bez lepení na podklad, střechy s nestandardním profilem a oplechování zdiva.

STŘEŠNÍ PÁSOVÁ DILATACE

Rozvinutá šířka žlabu	Hliník	Pozink, Titan-zinek, Měď, Nerez
< 500	8	10
> 500	6	8

Pre vonkajší roh alebo začiatok žlabu platí polovica štandardnej hodnoty. Pre vnútorný roh platí jedna štvrtina štandardnej hodnoty.

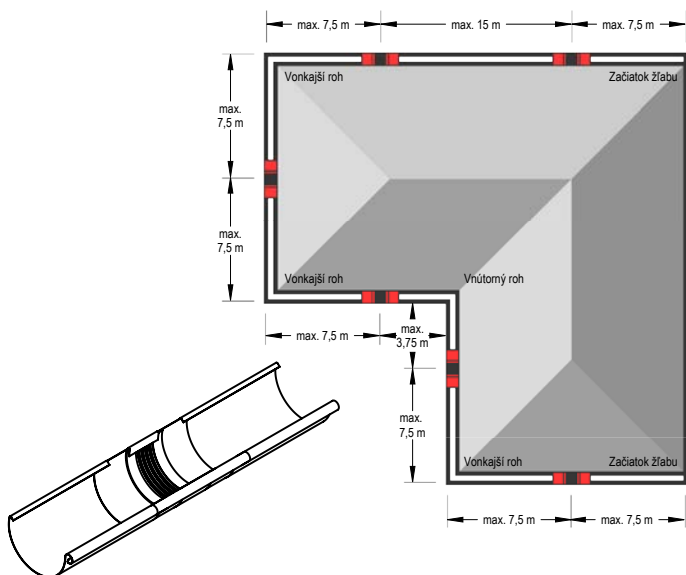

Poznámka k montáži dilatačního žlabu.

Při montáži pomocí pájení nejprve střední gumový díl překryjte mokrým hadříkem (aby nedošlo k prostupu tepla do středního gumového dílu). Musí se dodržet minimální vzdálenost 6 cm od střední gumové části. V každém případě je třeba se vyhnout kontaktu gumy s otevřeným plamenem.

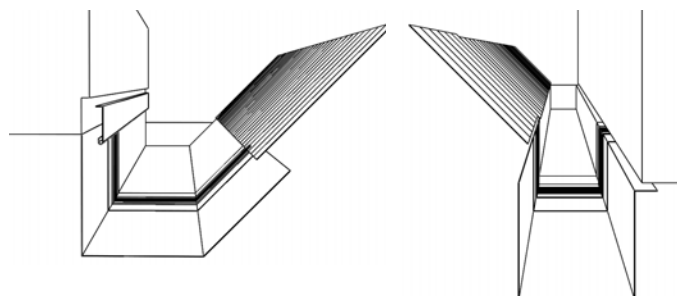

Poznámka k montáži dilatačního pásu.

Při ohýbání a montáži dilatačních prvků se ujistěte, že:

- ohýbací čelisti mají rádius minimálně 2 mm.
- pro tloušťku plechu od 1 mm musí být dodržen poloměr ohybu minimálně 5 mm.
- ohýbací čelisti musí být při ohýbání nastaveny na tloušťku střední gumové části 3 až 4 mm, aby se zabránilo stříhacího efektu - poškození gumy.
- Gumová střední část nesmí být během ohýbání stlačena nebo poškozená. Proto by měl být použit hliníkový plechový pás 2 až 5 mm (hrubý) ohnutý tak, aby mohl být připevněn jako ochrana na ohýbací čelisti. Tím se dosáhne větší poloměr ohybu a zabrání se porušení gumové střední části.

HLINÍKOVÁ MŘÍŽKA ZACHYTÁVAČE NEČISTOT

P-PZNL M

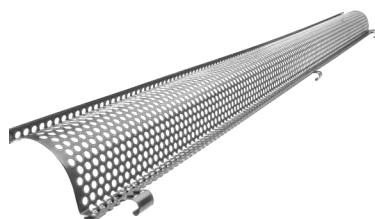



Jmenovitá velikost	333
Délka v m	2,0
Cena v CZK/ks	S DPH
TM 1 Testa di Moro RAL 8028	898,00 064943
AN 2 Antracit RAL 7016	898,00 064912
IC 3 Intenzivní černá RAL 9005	898,00 064929 *
OC 4 Ocelově červená RAL 3009	898,00 064936 *
MH 5 Měděno hnědá RAL 8004	898,00 119766 *
SB 6 Šedo bílá RAL 9002	898,00 117762 *
BH 7 Bílo hliníková RAL 9006	898,00 117717 *
PS 8 Prachově šedá RAL 7037	898,00 117755 *
MM 9 Metalická měděná RAL extra	898,00 117724 *
BHT – P.20 10 Bílo hliníková tmavá RAL 9007	898,00 097156 *
MZ 11 Mechově zelená RAL 6005	898,00 117748 *
MOT 12 Modrá tmavá RAL 5010	898,00 117731 *
TZ 13 Trávově zelená RAL 6011	898,00 117779 *
Balení v ks	15
Balení v ks	120

* Výroba na objednávku

POZINK POLYESTER



PVC MŘÍŽKA ZACHYTÁVAČE LISTÍ

SD-ZNL MŘEZKA

Jmenovitá velikost	Délka v m	EAN číslo výrobku	Balení v ks		Cena s DPH [CZK/ks]
					
PS 171	1,0	008473	30	450	152,00
TM 171	1,0	008466	30	450	152,00

PVC MŘÍŽKA ZACHYTÁVAČE LISTÍ

SD-ZNL N

Jmenovitá velikost	Délka v m	EAN číslo výrobku	Balení v ks		Cena s DPH [CZK/ks]
					
250	3,0	008480	10	400	810,00
280-333	3,0	008497	10	400	813,00

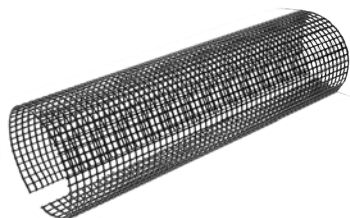
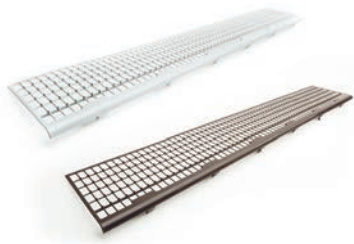

DRŽÁK NÁVALKY

P-PDZNV

Jmenovitá velikost	250-280	333	400
Rozměr v mm	18	20	22
Cena v CZK/ks	S DPH	S DPH	S DPH
TM 1 Testa di Moro RAL 8028	54,00 085665	54,00 085672	54,00 085689 *
AN 2 Antracit RAL 7016	54,00 085290	54,00 085306	54,00 085313
IC 3 Intenzivní černá RAL 9005	54,00 085351	54,00 085368	54,00 085375 *
OC 4 Ocelově červená RAL 3009	54,00 085504	54,00 085573	54,00 085597 *
MH 5 Měděno hnědá RAL 8004	54,00 085382	54,00 085399	54,00 085405 *
SB 6 Šedo bílá RAL 9002	54,00 085634 *	54,00 085641	54,00 085658 *
BH 7 Bílo hliníková RAL 9006	54,00 085320	54,00 085337	54,00 085344 *
PS 8 Prachově šedá RAL 7037	54,00 085603	54,00 085610	54,00 085627 *
MM 9 Metalická měděná RAL extra	54,00 085412 *	54,00 085429	54,00 085436 *
BHT – P.20 10 Bílo hliníková tmavá RAL 9007	54,00 094636 *	54,00 094643 *	54,00 094650 *
MZ 11 Mechově zelená RAL 6005	54,00 085474 *	54,00 085481 *	54,00 085498 *
MOT 12 Modrá tmavá RAL 5010	54,00 085443 *	54,00 085450 *	54,00 085467 *
TZ 13 Trávově zelená RAL 6011	54,00 085696 *	54,00 085702 *	54,00 085719 *
Balení v ks 	25	25	25
Balení v ks 	3 000	3 000	3 000

* Výroba na objednávku



SPOJKA ŽLABU

P-PSPZ

Jmenovitá velikost	250	280	333
Cena v CZK/ks	S DPH	S DPH	S DPH
TM 1 Testa di Moro RAL 8028	129,00 083852	129,00 083869	136,00 083876
AN 2 Antracit RAL 7016	129,00 083456	129,00 083463	136,00 083470
IC 3 Intenzivní černá RAL 9005	129,00 083531	129,00 083548	136,00 083555
OC 4 Ocelově červená RAL 3009	129,00 083739	129,00 083746	136,00 083753
MH 5 Méděno hnědá RAL 8004	129,00 083579	129,00 083586	136,00 083593
SB 6 Šedo bílá RAL 9002	129,00 083814	129,00 083821	136,00 083838
BH 7 Bílo hliníková RAL 9006	129,00 083494	129,00 083500	136,00 083517
PS 8 Prachově šedá RAL 7037	129,00 083777	129,00 083784	136,00 083791
MM 9 Metalická měděná RAL extra	129,00 083616	129,00 083623	136,00 083630
BHT – P.20 10 Bílo hliníková tmavá RAL 9007	129,00 094681	129,00 094698 *	136,00 094704
MZ 11 Mehově zelená RAL 6005	129,00 083692	129,00 083708	136,00 083715
MOT 12 Modrá tmavá RAL 5010	129,00 083654	129,00 083661	136,00 083678
TZ 13 Trávnově zelená RAL 6011	129,00 083890 *	129,00 083906 *	136,00 083913
Balení v ks 	5	5	5
Balení v ks 	600	600	600

* Výroba na objednávku

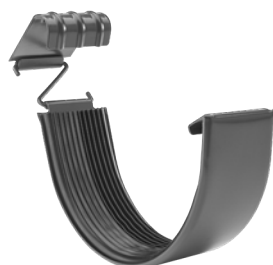

STŘEŠNÍ ŽLABOVÝ HÁK S PROLISEM

P-PHP

Jmenovitá velikost	200/380	250/430	280/480	280/480
Materiál	25/4	25/5	25/5	30/5
Cena v CZK/ks	S DPH	S DPH	S DPH	S DPH
TM 1 Testa di Moro RAL 8028	112,00 045362	100,00 045379	107,00 045386	117,00 045393
AN 2 Antracit RAL 7016	112,00 044648	100,00 044655	107,00 044662	117,00 044679
IC 3 Intenzivní černá RAL 9005	112,00 044808	100,00 044815	107,00 044822	117,00 044839
OC 4 Ocelově červená RAL 3009	112,00 045140	100,00 045157	107,00 045164	117,00 045171
MH 5 Měděno hnědá RAL 8004	112,00 044884	100,00 044891	107,00 044907	117,00 044914
SB 6 Šedo bílá RAL 9002	112,00 045287	100,00 045294	107,00 045300	117,00 045317
BH 7 Bílo hliníková RAL 9006	112,00 044723	100,00 044730	107,00 044747	117,00 044754
PS 8 Prachově šedá RAL 7037	112,00 045225	100,00 045232		117,00 045249
MM 9 Metalická měděná RAL extra	112,00 044969	100,00 044976		117,00 044983
BHT – P.20 10 Bílo hliníková tmavá RAL 9007		100,00 095961		117,00 095978
MZ 11 Mechově zelená RAL 6005	112,00 045089	100,00 045096		117,00 045102
MOT 12 Modrá tmavá RAL 5010	112,00 045027	100,00 045034		117,00 045041
TZ 13 Trávově zelená RAL 6011	112,00 045454 *	100,00 045461		117,00 045478
Balení v ks 📦	25	25	25	25
Balení v ks 🚚	1 000	1 000	1 000	1 000

* Výroba na objednávku



STŘEŠNÍ ŽLABOVÝ HÁK S PROLISEM

P-PHP

Jmenovitá velikost	333/550	333/550	333/550	333/610	400/610
Materiál	25/5	30/4	30/5	30/5	30/6
Cena v CZK/ks	S DPH	S DPH	S DPH	S DPH	S DPH
TM 1 Testa di Moro RAL 8028	107,00	112,00	119,00	139,00	200,00
	045409	045416 *	045423	045430	045447
AN 2 Antracit RAL 7016	107,00	112,00	119,00	139,00	200,00
	044686	080127 *	044693	044709	044716
IC 3 Intenzivní černá RAL 9005	107,00		119,00	139,00	200,00
	044846		044853	044860	044877
OC 4 Ocelově červená RAL 3009	107,00		119,00	139,00	200,00
	045188		045195	045201	045218
MH 5 Měděno hnědá RAL 8004	107,00		119,00	139,00	200,00
	044921		044938	044945	044952
SB 6 Šedo bílá RAL 9002	107,00		119,00	139,00	200,00
	045324		045331	045348	045355
BH 7 Bílo hliníková RAL 9006	107,00		119,00	139,00	200,00
	044761		044778	044785	044792
PS 8 Prachově šedá RAL 7037			119,00	139,00	200,00
			045256	045263	045270
MM 9 Metalická měděná RAL extra			119,00	139,00	200,00
			044990	045003	045010
BHT – P.20 10 Bílo hliníková tmavá RAL 9007			119,00		200,00
			095985		095992
MZ 11 Mechově zelená RAL 6005			119,00	139,00	200,00
			045119	045126	045133
MOT 12 Modrá tmavá RAL 5010			119,00	139,00	200,00
			045058	045065	045072
TZ 13 Trávově zelená RAL 6011			119,00	139,00	200,00
			045485	045492	045508 *
Balení v ks 📦	25	25	25	25	25
Balení v ks 🚚	1 000	1 000	1 000	1 000	500



* Výroba na objednávku



POZINK
POLYESTER

ŽLABOVÝ HÁK S PROLISEM NOSOVÝ



P-PHPN

Jmenovitá velikost	250/430	280/480	333/550
Materiál	25/5	25/5	25/5
Cena v CZK/ks	S DPH	S DPH	S DPH
TM 1 Testa di Moro RAL 8028	98,00 095930	98,00 095947	108,00 095954
AN 2 Antracit RAL 7016	98,00 095824	98,00 095831	108,00 095848
IC 3 Intenzivní černá RAL 9005		98,00 095879	108,00 095886 *
MH 5 Měděno hnědá RAL 8004		98,00 095893	108,00 095909
SB 6 Šedo bílá RAL 9002		98,00 095916	108,00 095923 *
BH 7 Bílo hliníková RAL 9006		98,00 095855	108,00 095862
PS 8 Prachově šedá RAL 7037			108,00 117496 *
Balení v ks 	25	25	25
Balení v ks 	1 000	1 000	1 000

* Výroba na objednávku

HÁK ŽLABOVÝ PRO ČELNÍ MONTÁŽ NOSOVÝ

P-PHPNK



Jmenovitá velikost	250	280	333
Materiál	25/4	25/4	25/5
Cena v CZK/ks	S DPH	S DPH	S DPH
TM 1 Testa di Moro RAL 8028	107,00 095435	113,00 095442	120,00 095459
AN 2 Antracit RAL 7016	107,00 095312	113,00 095329	120,00 095336
IC 3 Intenzivní černá RAL 9005	107,00 095374	113,00 095381	120,00 095398
MH 5 Měděno hnědá RAL 8004	107,00 095404	113,00 095411	120,00 095428
BH 7 Bílo hliníková RAL 9006	107,00 095343 *	113,00 095350	120,00 095367
Balení v ks 	25	25	25
Balení v ks 	1 000	1 000	1 000

* Výroba na objednávku



HÁK ŽLABOVÝ NÁSTRĚŠNÍ

P-PHSSN

Jmenovitá velikost	4
Materiál	20/6
Cena v CZK/ks	S DPH
TM 1 Testa di Moro RAL 8028	291,00 033567
AN 2 Antracit RAL 7016	291,00 033468
IC 3 Intenzivní černá RAL 9005	291,00 033482
OC 4 Ocelově červená RAL 3009	291,00 033536
MH 5 Měděno hnědá RAL 8004	291,00 033499
SB 6 Šedo bílá RAL 9002	291,00 033550
BH 7 Bílo hliníková RAL 9006	291,00 033475
PS 8 Prachově šedá RAL 7037	291,00 033543
MM 9 Metalická měděná RAL extra	291,00 033505
BHT – P.20 10 Bílo hliníková tmavá RAL 9007	291,00 095510 *
MZ 11 Mehově zelená RAL 6005	291,00 033529
MOT 12 Modrá tmavá RAL 5010	291,00 033512 *
TZ 13 Trávově zelená RAL 6011	291,00 033574
Balení v ks 	25
Balení v ks 	1 000

* Výroba na objednávku



POZINK
POLYESTER

HÁK ŽLABOVÝ ČELNÍ

P-PHPK



Jmenovitá velikost	200	250	280	333	400
Materiál	25/4	25/4	25/4	25/5	30/5
Cena v CZK/ks	S DPH	S DPH	S DPH	S DPH	S DPH
TM 1 Testa di Moro RAL 8028	122,00	115,00	124,00	134,00	186,00
	065551	065568	065575	065582	065599
AN 2 Antracit RAL 7016	122,00	115,00	124,00	134,00	186,00
	065056	065063	065070	065087	065094
IC 3 Intenzivní černá RAL 9005	122,00	115,00	124,00	134,00	186,00
	065155	065162	065179	065186	065193 *
OC 4 Ocelově červená RAL 3009	122,00	115,00	124,00	134,00	186,00
	065407	065414	065421	065438	065445
MH 5 Měděno hnědá RAL 8004	122,00	115,00	124,00	134,00	186,00
	065209	065216	065223	065230	065247 *
SB 6 Šedo bílá RAL 9002	122,00	115,00	124,00	134,00	186,00
	065506	065513	065520	065537	065544
BH 7 Bílo hliníková RAL 9006	122,00	115,00	124,00	134,00	186,00
	065100	065117	065124	065131	065148
PS 8 Prachově šedá RAL 7037	122,00	115,00	124,00	134,00	186,00
	065452	065469	065476	065483	065490
MM 9 Metalická měděná RAL extra	122,00	115,00	124,00	134,00	186,00
	065254	065261	065278	065285	065292 *
BHT – P.20 10 Bílo hliníková tmavá RAL 9007		115,00	124,00	134,00	
		095251	095268	095275	
MZ 11 Mechově zelená RAL 6005	122,00	115,00	124,00	134,00	186,00
	065353	065360	065377	065384	065391 *
MOT 12 Modrá tmavá RAL 5010	122,00	115,00	124,00	134,00	186,00
	065308 *	065315	065322	065339	065346
TZ 13 Trávově zelená RAL 6011	122,00	115,00	124,00	134,00	186,00
	065605 *	065612 *	065629 *	065636 *	065643 *
Balení v ks 	25	25	25	25	20
Balení v ks 	1 000	1 000	1 000	1 000	800

* Výroba na objednávku

ROH VNĚJŠÍ

P-PRA

Jmenovitá velikost	200	250	280	333	400
Cena v CZK/ks	S DPH	S DPH	S DPH	S DPH	S DPH
TM 1 Testa di Moro RAL 8028	403,00 075673	396,00 075680	400,00 075697	403,00 075703	1013,00 075710
AN 2 Antracit RAL 7016	403,00 075178	396,00 075185	400,00 075192	403,00 075208	1013,00 075215
IC 3 Intenzivní černá RAL 9005	403,00 075260	396,00 075284	400,00 075291	403,00 075307	1013,00 075314
OC 4 Ocelově červená RAL 3009	403,00 075529	396,00 075536	400,00 075543	403,00 075567	1013,00 075550
MH 5 Méděno hnědá RAL 8004	403,00 075321	396,00 075338	400,00 075345	403,00 075352	1013,00 075369
SB 6 Šedo bílá RAL 9002	403,00 075635	396,00 075628	400,00 075642	403,00 075659	1013,00 075666
BH 7 Bílo hliníková RAL 9006	403,00 075222	396,00 075239	400,00 075246	403,00 075253	1013,00 075277
PS 8 Prachově šedá RAL 7037	403,00 075574	396,00 075581	400,00 075598	403,00 075604	1013,00 075611
MM 9 Metalická měděná RAL extra	403,00 075376	396,00 075383	400,00 075390	403,00 075406	1013,00 075413
BHT – P.20 10 Bílo hliníková tmavá RAL 9007		396,00 094384	400,00 094391 *	403,00 094407	1013,00 110695
MZ 11 Mechově zelená RAL 6005	403,00 075475	396,00 075482	400,00 075499	403,00 075505	1013,00 075512
MOT 12 Modrá tmavá RAL 5010	403,00 075420	396,00 075437	400,00 075444	403,00 075451	1013,00 075468
TZ 13 Trávnově zelená RAL 6011	403,00 075727 *	396,00 075734	400,00 075741	403,00 075758	1013,00 075765 *
Balení v ks 	5	5	5	5	5
Balení v ks 	150	150	150	150	150

* Výroba na objednávku

POZINK
POLYESTER



ROH VNITŘNÍ

P-PRI

Jmenovitá velikost	200	250	280	333	400
Cena v CZK/ks	S DPH	S DPH	S DPH	S DPH	S DPH
TM 1 Testa di Moro RAL 8028	403,00 076281	396,00 076274	400,00 076298	403,00 076304	1013,00 076311
AN 2 Antracit RAL 7016	403,00 075772	396,00 075789	400,00 075796	403,00 075802	1013,00 075819
IC 3 Intenzivní černá RAL 9005	403,00 075871	396,00 075888	400,00 075895	403,00 075901	1013,00 075918
OC 4 Ocelově červená RAL 3009	403,00 076120	396,00 076137	400,00 076144	403,00 076168	1013,00 076151
MH 5 Méděno hnědá RAL 8004	403,00 075925	396,00 075932	400,00 075949	403,00 075956	1013,00 075963
SB 6 Šedo bílá RAL 9002	403,00 076229	396,00 076236	400,00 076243	403,00 076250	1013,00 076267
BH 7 Bílo hliníková RAL 9006	403,00 075826	396,00 075833	400,00 075840	403,00 075857	1013,00 075864
PS 8 Prachově šedá RAL 7037	403,00 076175	396,00 076199	400,00 076182	403,00 076205	1013,00 076212
MM 9 Metalická měděná RAL extra	403,00 075970	396,00 075987	400,00 075994	403,00 076007	1013,00 076014
BHT – P.20 10 Bílo hliníková tmavá RAL 9007		396,00 094414	400,00 094421 *	403,00 094438	1013,00 110688
MZ 11 Mechově zelená RAL 6005	403,00 076076	396,00 076083	400,00 076090	403,00 076106	1013,00 076113
MOT 12 Modrá tmavá RAL 5010	403,00 076021 *	396,00 076038	400,00 076045	403,00 076052	1013,00 076069
TZ 13 Trávově zelená RAL 6011	403,00 076335 *	396,00 076328	400,00 076342	403,00 076359	1013,00 076366 *
Balení v ks 	5	5	5	5	5
Balení v ks 	150	150	150	150	150

* Výroba na objednávku



ČELO ŽLABOVÉ

P-PCL

Jmenovitá velikost	200	250	280	333	400
Cena v CZK/ks	S DPH	S DPH	S DPH	S DPH	S DPH
TM 1 Testa di Moro RAL 8028	49,00 003164	44,00 003171	47,00 003188	49,00 003195	76,00 003201
AN 2 Antracit RAL 7016	49,00 002662	44,00 002679	47,00 002686	49,00 002693	76,00 002709
IC 3 Intenzivní černá RAL 9005	49,00 002761	44,00 002778	47,00 002785	49,00 002792	76,00 002808
OC 4 Ocelově červená RAL 3009	49,00 003010	44,00 003027	47,00 003034	49,00 003041	76,00 003058
MH 5 Méděno hnědá RAL 8004	49,00 002815	44,00 002822	47,00 002839	49,00 002846	76,00 002853
SB 6 Šedo bílá RAL 9002	49,00 003119	44,00 003126	47,00 003133	49,00 003140	76,00 003157
BH 7 Bílo hliníková RAL 9006	49,00 002716	44,00 002723	47,00 002730	49,00 002747	76,00 002754
PS 8 Prachově šedá RAL 7037	49,00 003065	44,00 003072	47,00 003089	49,00 003096	76,00 003102
MM 9 Metalická měděná RAL extra	49,00 002860	44,00 002877	47,00 002884	49,00 002891	76,00 002907
BHT – P.20 10 Bílo hliníková tmavá RAL 9007		44,00 094568	47,00 094575 *	49,00 094582	76,00 094599
MZ 11 Mechově zelená RAL 6005	49,00 002969	44,00 002976	47,00 002983	49,00 002990	76,00 003003
MOT 12 Modrá tmavá RAL 5010	49,00 002914	44,00 002921	47,00 002938	49,00 002945	76,00 002952
TZ 13 Trávově zelená RAL 6011	49,00 003218 *	44,00 003225	47,00 003232	49,00 003249	76,00 003256
Balení v ks 	6/60	6/60	6/60	6/60	4/40
Balení v ks 	1 440	1 440	1 440	1 440	960

* Výroba na objednávku



ČELO ŽLABOVÉ S TĚSNĚNÍM

P-PCLG



Jmenovitá velikost	250	280	333
Cena v CZK/ks	S DPH	S DPH	S DPH
TM 1 Testa di Moro RAL 8028	90,00 004338	98,00 004345	102,00 004352
AN 2 Antracit RAL 7016	90,00 004031	98,00 004048	102,00 004055
IC 3 Intenzivní černá RAL 9005	90,00 004093	98,00 004109	102,00 004116
OC 4 Ocelově červená RAL 3009	90,00 004246	98,00 004253	102,00 004260
MH 5 Méděno hnědá RAL 8004	90,00 004123	98,00 004130	102,00 004147
SB 6 Šedo bílá RAL 9002	90,00 004307	98,00 004314	102,00 004321
BH 7 Bílo hliníková RAL 9006	90,00 004062	98,00 004079	102,00 004086
PS 8 Prachově šedá RAL 7037	90,00 004277	98,00 004284	102,00 004291
MM 9 Metalická měděná RAL extra	90,00 004154	98,00 004161	102,00 004178
BHT – P.20 10 Bílo hliníková tmavá RAL 9007	90,00 094605	98,00 094612 *	102,00 094629
MZ 11 Mechově zelená RAL 6005	90,00 004215	98,00 004222	102,00 004239
MOT 12 Modrá tmavá RAL 5010	90,00 004185	98,00 004192	102,00 004208
TZ 13 Trávově zelená RAL 6011	90,00 004369 *	98,00 004376 *	102,00 004383 *
Balení v ks 	4/40	4/40	4/40
Balení v ks 	960	960	960

* Výroba na objednávku

KOTLÍK ŽLABOVÝ

P-PKL

Jmenovitá velikost	200/60	250/60	250/80	280/80	280/100
Cena v CZK/ks	S DPH	S DPH	S DPH	S DPH	S DPH
TM 1 Testa di Moro RAL 8028	251,00	305,00	224,00	244,00	244,00
	067357	067364	067371	067388	067395
AN 2 Antracit RAL 7016	251,00	305,00	224,00	244,00	244,00
	066251	066268	066275	066282	066299
IC 3 Intenzivní černá RAL 9005	251,00	305,00	224,00	244,00	244,00
	066473	066480	066497	066503	066510
OC 4 Ocelově červená RAL 3009	251,00	305,00	224,00	244,00	244,00
	067029	067036	067043	067050	067067
MH 5 Méděno hnědá RAL 8004	251,00	305,00	224,00	244,00	244,00
	066589	066596	066602	066619	066626
SB 6 Šedo bílá RAL 9002	251,00	305,00	224,00	244,00	244,00
	067241	067258	067265	067272	067289
BH 7 Bílo hliníková RAL 9006	251,00	305,00	224,00	244,00	244,00
	066367	066374	066381	066398	066404
PS 8 Prachově šedá RAL 7037	251,00	305,00	224,00	244,00	244,00
	067135	067142 *	067159	067166	067173
MM 9 Metalická měděná RAL extra	251,00	305,00	224,00	244,00	244,00
	066695	066701 *	066718	066725	066732
BHT – P.20 10 Bílo hliníková tmavá RAL 9007	251,00	305,00	224,00	244,00	244,00
	119728 *	119735 *	094469	094476	094483
MZ 11 Mechově zelená RAL 6005	251,00	305,00	224,00	244,00	244,00
	066916	066923	066930	066947	066954
MOT 12 Modrá tmavá RAL 5010	251,00	305,00	224,00	244,00	244,00
	066800 *	066817 *	066824	066831	066848
TZ 13 Trávově zelená RAL 6011	251,00	305,00	224,00	244,00	244,00
	067463 *	067470 *	067487	067494 *	067500
Balení v ks 	20	20	20	20	20
Balení v ks 	600	600	600	600	600

* Výroba na objednávku



KOTLÍK ŽLABOVÝ

P-PKL





Jmenovitá velikost	333/80	333/100	333/120
Cena v CZK/ks	S DPH	S DPH	S DPH
TM 1 Testa di Moro RAL 8028	285,00 067401	269,00 067418	322,00 067425
AN 2 Antracit RAL 7016	285,00 066305	269,00 066312	322,00 066329
IC 3 Intenzivní černá RAL 9005	285,00 066527	269,00 066534	322,00 066541
OC 4 Ocelově červená RAL 3009	285,00 067074	269,00 067081	322,00 067098
MH 5 Méděno hnědá RAL 8004	285,00 066633	269,00 066640	322,00 066657
SB 6 Šedo bílá RAL 9002	285,00 067296	269,00 067302	322,00 067326
BH 7 Bílo hliníková RAL 9006	285,00 066411	269,00 066428	322,00 066435
PS 8 Prachově šedá RAL 7037	285,00 067180	269,00 067197	322,00 067203
MM 9 Metalická měděná RAL extra	285,00 066749	269,00 066756	322,00 066763
BHT – P.20 10 Bílo hliníková tmavá RAL 9007	285,00 094490 *	269,00 094506	322,00 094513
MZ 11 Mehově zelená RAL 6005	285,00 066961	269,00 066978	322,00 066985
MOT 12 Modrá tmavá RAL 5010	285,00 066855 *	269,00 066862	322,00 066879
TZ 13 Trávově zelená RAL 6011	285,00 067517 *	269,00 067524	322,00 067531
Balení v ks 	20	20	15
Balení v ks 	600	600	300

* Výroba na objednávku

KOTLÍK ŽLABOVÝ

P-PKL

Jmenovitá velikost	400/100	400/120	400/150
Cena v CZK/ks	S DPH	S DPH	S DPH
TM 1 Testa di Moro RAL 8028	644,00 067432	644,00 067449	728,00 067456
AN 2 Antracit RAL 7016	644,00 066336	644,00 066343	728,00 066350
IC 3 Intenzivní černá RAL 9005	644,00 066558	644,00 066565	728,00 066572
OC 4 Ocelově červená RAL 3009	644,00 067104 *	644,00 067111	728,00 067128
MH 5 Méděno hnědá RAL 8004	644,00 066664 *	644,00 066671	728,00 066688
SB 6 Šedo bílá RAL 9002	644,00 067319	644,00 067333	728,00 067340
BH 7 Bílo hliníková RAL 9006	644,00 066442	644,00 066459	728,00 066466
PS 8 Prachově šedá RAL 7037	644,00 067210	644,00 067227	728,00 067234
MM 9 Metalická měděná RAL extra	644,00 066770 *	644,00 066787 *	728,00 066794 *
BHT – P.20 10 Bílo hliníková tmavá RAL 9007	644,00 119742 *	644,00 094520	728,00 094667
MZ 11 Mechově zelená RAL 6005	644,00 066992 *	644,00 067005	728,00 067012
MOT 12 Modrá tmavá RAL 5010	644,00 066886 *	644,00 066893	728,00 066909
TZ 13 Trávově zelená RAL 6011	644,00 067548 *	644,00 067555	728,00 067562 *
Balení v ks 	15	15	15
Balení v ks 	300	300	300

* Výroba na objednávku



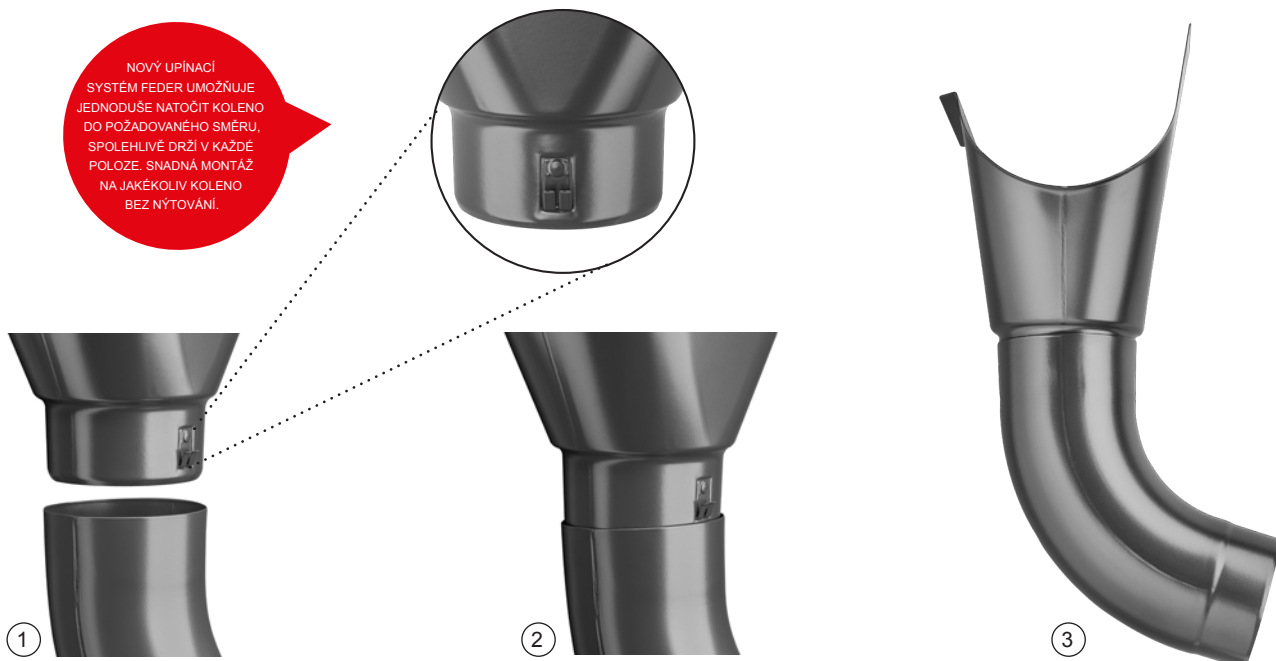

NOVÝ UPINACÍ
SYSTÉM FEDER UMOŽŇUJE
JEDNODUŠE NATOČIT KOLENO
DO POŽADOVANÉHO SMĚRU,
SPOLEHLIVĚ DRŽÍ V KAŽDÉ
POLOZE. SNADNÁ MONTÁŽ
NA JAKÉKOLIV KOLENO
BEZ NÝTOVÁNÍ.



HRDLO ŽLABOVÉ

P-PHRD

Jmenovitá velikost	80	100	120
Cena v CZK/ks	S DPH	S DPH	S DPH
TM 1 Testa di Moro RAL 8028	56,00 066015	59,00 066022	71,00 066039
AN 2 Antracit RAL 7016	56,00 065711	59,00 065728	71,00 065735 *
IC 3 Intenzivní černá RAL 9005	56,00 065773 *	59,00 065780	71,00 065797 *
OC 4 Ocelově červená RAL 3009	56,00 065926 *	59,00 065933	71,00 065940 *
MH 5 Méděno hnědá RAL 8004	56,00 065803 *	59,00 065810	71,00 065827 *
SB 6 Šedo bílá RAL 9002	56,00 065988 *	59,00 065995 *	71,00 066008 *
BH 7 Bílo hliníková RAL 9006	56,00 065742 *	59,00 065759 *	71,00 065766 *
PS 8 Prachově šedá RAL 7037	56,00 065957 *	59,00 065964 *	71,00 065971 *
MM 9 Metalická měděná RAL extra	56,00 065834 *	59,00 065841 *	71,00 065858 *
BHT – P.20 10 Bílo hliníková tmavá RAL 9007			
MZ 11 Mechově zelená RAL 6005	56,00 065896 *	59,00 065902 *	71,00 065919 *
MOT 12 Modrá tmavá RAL 5010	56,00 065865 *	59,00 065872 *	71,00 065889 *
TZ 13 Trávově zelená RAL 6011	56,00 066046 *	59,00 066053 *	71,00 066060 *
Balení v ks 	25	25	15
Balení v ks 	1 000	1 000	750



* Výroba na objednávku



NEREZOVÝ LPAČ LISTÍ

N-NZN



Jmenovitá velikost	EAN číslo výrobku	Balení v ks		Cena s DPH [CZK/ks]
				
60	001153	30	2 160	188,00
80	001160	20	1 440	190,00
100	001177	15	1 080	193,00
120	001184	10	720	210,00
150	001191	5	360	332,00



SBĚRNÝ KOTLÍK DESIGN

P-PKLZ DE



POZINK
POLYESTER

Jmenovitá velikost	80	100	120
Cena v CZK/ks	S DPH	S DPH	S DPH
TM 1 Testa di Moro RAL 8028	1 965,00 027702	1 965,00 027726	2 168,00 027740
AN 2 Antracit RAL 7016	1 965,00 026200	1 965,00 026224	2 168,00 026248
IC 3 Intenzivní černá RAL 9005	1 965,00 026507	1 965,00 026521	2 168,00 026545
OC 4 Ocelově červená RAL 3009	1 965,00 027252 *	1 965,00 027276	2 168,00 027290
MH 5 Méděno hnědá RAL 8004	1 965,00 026651	1 965,00 026675	2 168,00 026699
SB 6 Šedo bílá RAL 9002	1 965,00 027559 *	1 965,00 027573	2 168,00 027597
BH 7 Bílo hliníková RAL 9006	1 965,00 026354	1 965,00 026378	2 168,00 026392
PS 8 Prachově šedá RAL 7037	1 965,00 027405	1 965,00 027429	2 168,00 027443
MM 9 Metalická měděná RAL extra	1 965,00 026804 *	1 965,00 026828	2 168,00 026842
BHT – P.20 10 Bílo hliníková tmavá RAL 9007	1 965,00 096210	1 965,00 096265	2 168,00 096319
MZ 11 Mechově zelená RAL 6005	1 965,00 027108 *	1 965,00 027122	2 168,00 027146 *
MOT 12 Modrá tmavá RAL 5010	1 965,00 026958 *	1 965,00 026972	2 168,00 027009 *
TZ 13 Trávově zelená RAL 6011	1 965,00 027856 *	1 965,00 027870 *	2 168,00 027894 *
Balení v ks	2	2	2
Balení v ks	36	36	36

* Výroba na objednávku

SBĚRNÝ KOTLÍK DESIGN EXZENTRICKÝ

P-PKLZ DX



Jmenovitá velikost	80	100	120
Cena v CZK/ks	S DPH	S DPH	S DPH
TM 1 Testa di Moro RAL 8028	2 439,00 027764	2 439,00 027795	2 507,00 027825
AN 2 Antracit RAL 7016	2 439,00 026262	2 439,00 026293	2 507,00 026323
IC 3 Intenzivní černá RAL 9005	2 439,00 026569	2 439,00 026590	2 507,00 026620 *
OC 4 Ocelově červená RAL 3009	2 439,00 027313	2 439,00 027344	2 507,00 027375 *
MH 5 Méděno hnědá RAL 8004	2 439,00 026712 *	2 439,00 026743 *	2 507,00 026774 *
SB 6 Šedo bílá RAL 9002	2 439,00 027610 *	2 439,00 027641	2 507,00 027672
BH 7 Bílo hliníková RAL 9006	2 439,00 026415 *	2 439,00 026446	2 507,00 026477
PS 8 Prachově šedá RAL 7037	2 439,00 027467 *	2 439,00 027498	2 507,00 027528
MM 9 Metalická měděná RAL extra	2 439,00 026866 *	2 439,00 026897	2 507,00 026927 *
BHT – P.20 10 Bílo hliníková tmavá RAL 9007	2 439,00 096203 *	2 439,00 096258	2 507,00 096302
MZ 11 Mechově zelená RAL 6005	2 439,00 027160 *	2 439,00 027191 *	2 507,00 027221 *
MOT 12 Modrá tmavá RAL 5010	2 439,00 027016 *	2 439,00 027047 *	2 507,00 027078 *
TZ 13 Trávově zelená RAL 6011	2 439,00 027917 *	2 439,00 027948 *	2 507,00 027979 *
Balení v ks 	2	2	2
Balení v ks 	36	36	36

* Výroba na objednávku

SBĚRNÝ KOTLÍK KUBICKÝ

P-PKLZ KU



Jmenovitá velikost	80	100	120
Cena v CZK/ks	S DPH	S DPH	S DPH
TM 1 Testa di Moro RAL 8028	2 981,00 027719 *	2 981,00 027733	3 185,00 027757
AN 2 Antracit RAL 7016	2 981,00 026217	2 981,00 026231	3 185,00 026255
IC 3 Intenzivní černá RAL 9005	2 981,00 026514	2 981,00 026538	3 185,00 026552
OC 4 Ocelově červená RAL 3009	2 981,00 027269 *	2 981,00 027283 *	3 185,00 027306
MH 5 Méděno hnědá RAL 8004	2 981,00 026668 *	2 981,00 026682 *	3 185,00 026705 *
SB 6 Šedo bílá RAL 9002	2 981,00 027566 *	2 981,00 027580 *	3 185,00 027603 *
BH 7 Bílo hliníková RAL 9006	2 981,00 026361 *	2 981,00 026385	3 185,00 026408
PS 8 Prachově šedá RAL 7037	2 981,00 027412 *	2 981,00 027436 *	3 185,00 027450
MM 9 Metalická měděná RAL extra	2 981,00 026811 *	2 981,00 026835 *	3 185,00 026859 *
BHT – P.20 10 Bílo hliníková tmavá RAL 9007	2 981,00 096241 *	2 981,00 096296 *	3 185,00 096340 *
MZ 11 Mechově zelená RAL 6005	2 981,00 027115 *	2 981,00 027139 *	3 185,00 027153 *
MOT 12 Modrá tmavá RAL 5010	2 981,00 026965 *	2 981,00 026989 *	3 185,00 026996 *
TZ 13 Trávnově zelená RAL 6011	2 981,00 027863 *	2 981,00 027887 *	3 185,00 027900 *
Balení v ks 	2	2	2
Balení v ks 	36	36	36

* Výroba na objednávku

SBĚRNÝ KOTLÍK KUBICKÝ EXZENTRICKÝ

P-PKLZ KX



Jmenovitá velikost	80	100	120
Cena v CZK/ks	S DPH	S DPH	S DPH
TM 1 Testa di Moro RAL 8028	2 981,00 027788	2 981,00 027818	3 185,00 027849
AN 2 Antracit RAL 7016	2 981,00 026286	2 981,00 026316	3 185,00 026347
IC 3 Intenzivní černá RAL 9005	2 981,00 026583	2 981,00 026613	3 185,00 026644 *
OC 4 Ocelově červená RAL 3009	2 981,00 027337 *	2 981,00 027368	3 185,00 027399
MH 5 Méděno hnědá RAL 8004	2 981,00 026736	2 981,00 026767	3 185,00 026798 *
SB 6 Šedo bílá RAL 9002	2 981,00 027634 *	2 981,00 027665	3 185,00 027696
BH 7 Bílo hliníková RAL 9006	2 981,00 026439 *	2 981,00 026460	3 185,00 026491
PS 8 Prachově šedá RAL 7037	2 981,00 027481 *	2 981,00 027511	3 185,00 027542
MM 9 Metalická měděná RAL extra	2 981,00 026880 *	2 981,00 026910	3 185,00 026941 *
BHT – P.20 10 Bílo hliníková tmavá RAL 9007	2 981,00 096227	2 981,00 096272	3 185,00 096326
MZ 11 Mechově zelená RAL 6005	2 981,00 027184 *	2 981,00 027214	3 185,00 027245 *
MOT 12 Modrá tmavá RAL 5010	2 981,00 027030 *	2 981,00 027061 *	3 185,00 027092 *
TZ 13 Trávově zelená RAL 6011	2 981,00 027931 *	2 981,00 027962	3 185,00 027993 *
Balení v ks 	2	2	2
Balení v ks 	36	36	36

* Výroba na objednávku

SBĚRNÝ KOTLÍK KUBICKÝ EXZENTRICKÝ S VÝTOKEM

P-PKLZ KXV



Jmenovitá velikost	80	100	120
Cena v CZK/ks	S DPH	S DPH	S DPH
TM 1 Testa di Moro RAL 8028	3 896,00 027771 *	3 896,00 027801 *	3 896,00 027832 *
AN 2 Antracit RAL 7016	3 896,00 026279 *	3 896,00 026309 *	3 896,00 026330 *
IC 3 Intenzivní černá RAL 9005	3 896,00 026576 *	3 896,00 026606	3 896,00 026637 *
OC 4 Ocelově červená RAL 3009	3 896,00 027320 *	3 896,00 027351 *	3 896,00 027382 *
MH 5 Méděno hnědá RAL 8004	3 896,00 026729 *	3 896,00 026750 *	3 896,00 026781 *
SB 6 Šedo bílá RAL 9002	3 896,00 027627 *	3 896,00 027658 *	3 896,00 027689 *
BH 7 Bílo hliníková RAL 9006	3 896,00 026422 *	3 896,00 026453 *	3 896,00 026484 *
PS 8 Prachově šedá RAL 7037	3 896,00 027474 *	3 896,00 027504 *	3 896,00 027535 *
MM 9 Metalická měděná RAL extra	3 896,00 026873 *	3 896,00 026903 *	3 896,00 026934 *
BHT – P.20 10 Bílo hliníková tmavá RAL 9007	3 896,00 096234 *	3 896,00 096289 *	3 896,00 096333 *
MZ 11 Mechově zelená RAL 6005	3 896,00 027177 *	3 896,00 027207 *	3 896,00 027238 *
MOT 12 Modrá tmavá RAL 5010	3 896,00 027023 *	3 896,00 027054 *	3 896,00 027085 *
TZ 13 Trávnově zelená RAL 6011	3 896,00 027924 *	3 896,00 027955 *	3 896,00 027986 *
Balení v ks 	2	2	2
Balení v ks 	36	36	36

* Výroba na objednávku

TĚSNÍCI GUMA SBĚRNÉHO KOTLÍKA

P-PKLZ T



Jmenovitá velikost	EAN číslo výrobku	Balení v ks		Cena s DPH [CZK/ks]
IC 70-85	077103	5	600	136,00
IC 100-110	077110	5	600	139,00
IC 110-125	077097	5	600	142,00
PS 70-85	077134	5	600	152,00
PS 100-110	077141	5	600	166,00
PS 110-125	077127	5	600	169,00

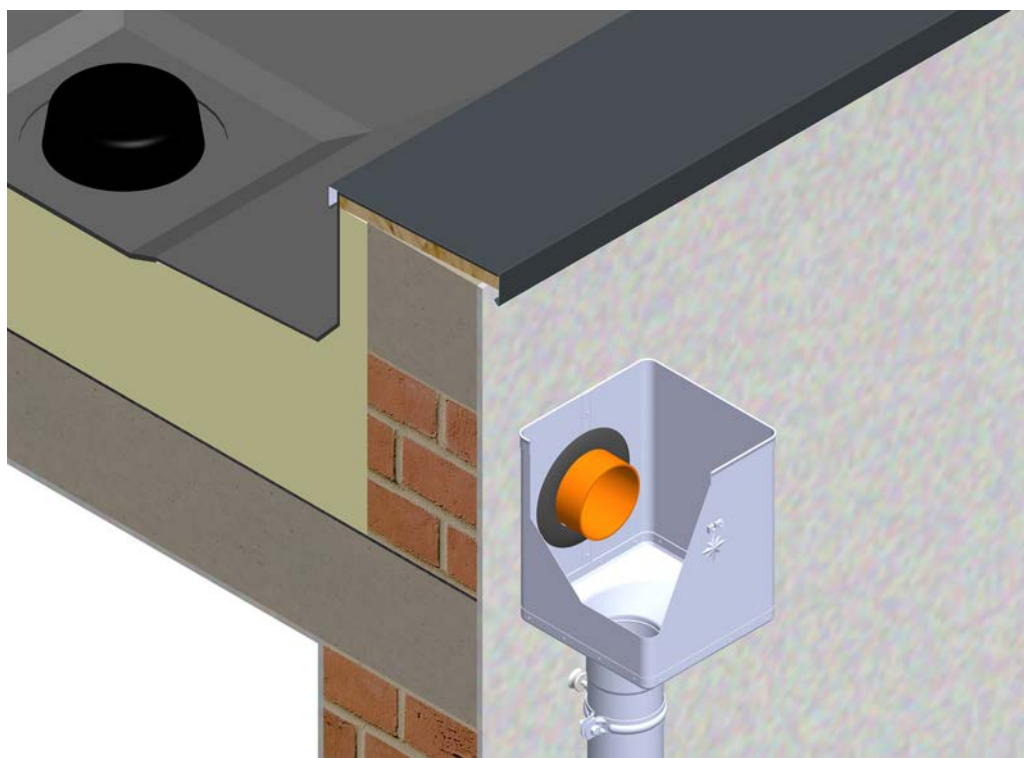

SVODOVÉ KOLENO 72°

P-PK

Jmenovitá velikost	60	80	100	120	150
Cena v CZK/ks	S DPH	S DPH	S DPH	S DPH	S DPH
TM 1 Testa di Moro RAL 8028	203,00 072542	186,00 072559	203,00 072573	288,00 072597	676,00 033697
AN 2 Antracit RAL 7016	203,00 071842	186,00 071859	203,00 071873	288,00 071897	676,00 033598
IC 3 Intenzivní černá RAL 9005	203,00 071989	186,00 072023	203,00 072009	288,00 072030	676,00 033611
OC 4 Ocelově červená RAL 3009	203,00 072337	186,00 072344	203,00 072368	288,00 072382	676,00 033666
MH 5 Méděno hnědá RAL 8004	203,00 072054	186,00 072061	203,00 072085	288,00 072108	676,00 033628
SB 6 Šedo bílá RAL 9002	203,00 072474	186,00 072481	203,00 072504	288,00 072528	676,00 033680
BH 7 Bílo hliníková RAL 9006	203,00 071910	186,00 071927	203,00 071941	288,00 071965	676,00 033604
PS 8 Prachově šedá RAL 7037	203,00 072405	186,00 072412	203,00 072429	288,00 072443	676,00 033673
MM 9 Metalická měděná RAL extra	203,00 072122	186,00 072139	203,00 072153	288,00 072160	676,00 033635
BHT – P.20 10 Bílo hliníková tmavá RAL 9007	203,00 118691 *	186,00 095183	203,00 095206	288,00 095220	676,00 095244
MZ 11 Mechově zelená RAL 6005	203,00 072269	186,00 072276	203,00 072290	288,00 072313	676,00 033659
MOT 12 Modrá tmavá RAL 5010	203,00 072191	186,00 072207	203,00 072221	288,00 072245	676,00 033642
TZ 13 Trávově zelená RAL 6011	203,00 072610 *	186,00 072627	203,00 072641	288,00 072665	676,00 033703 *
Balení v ks 📦	25	25	25	15	5
Balení v ks 🚚	600	400	300	180	90

* Výroba na objednávku



SVODOVÉ KOLENO 85°

P-PKR



Jmenovitá velikost	80	100	120
Cena v CZK/ks	S DPH	S DPH	S DPH
TM 1 Testa di Moro RAL 8028	234,00 072566	264,00 072580	420,00 072603
AN 2 Antracit RAL 7016	234,00 071866	264,00 071880	420,00 071903
IC 3 Intenzivní černá RAL 9005	234,00 071996	264,00 072016	420,00 072047
OC 4 Ocelově červená RAL 3009	234,00 072351	264,00 072375	420,00 072399
MH 5 Měděno hnědá RAL 8004	234,00 072078	264,00 072092	420,00 072115
SB 6 Šedo bílá RAL 9002	234,00 072498	264,00 072511	420,00 072535
BH 7 Bílo hliníková RAL 9006	234,00 071934	264,00 071958	420,00 071972
PS 8 Prachově šedá RAL 7037	234,00 072467	264,00 072436	420,00 072450
MM 9 Metalická měděná RAL extra	234,00 072146	264,00 072184	420,00 072177
BHT – P.20 10 Bílo hliníková tmavá RAL 9007	234,00 095190	264,00 095213	420,00 095237 *
MZ 11 Mechově zelená RAL 6005	234,00 072283	264,00 072306	420,00 072320
MOT 12 Modrá tmavá RAL 5010	234,00 072214 *	264,00 072238 *	420,00 072252 *
TZ 13 Trávově zelená RAL 6011	234,00 072634 *	264,00 072658 *	420,00 072672 *
Balení v ks 	25	25	15
Balení v ks 	400	300	180

* Výroba na objednávku

SVODOVÉ KOLENO TUPÉ 40°

P-PKT

Jmenovitá velikost	80	100	120
Cena v CZK/ks	S DPH	S DPH	S DPH
TM 1 Testa di Moro RAL 8028	220,00 072993	241,00 073006	339,00 073013
AN 2 Antracit RAL 7016	220,00 072696	241,00 072702	339,00 072719
IC 3 Intenzivní černá RAL 9005	220,00 072757	241,00 072764	339,00 072771
OC 4 Ocelově červená RAL 3009	220,00 072900	241,00 072917	339,00 072924
MH 5 Méděno hnědá RAL 8004	220,00 072795	241,00 072788	339,00 072801
SB 6 Šedo bílá RAL 9002	220,00 072962	241,00 072979	339,00 072986
BH 7 Bílo hliníková RAL 9006	220,00 072726	241,00 072733	339,00 072740
PS 8 Prachově šedá RAL 7037	220,00 072931	241,00 072948	339,00 072955
MM 9 Metalická měděná RAL extra	220,00 072818	241,00 072825	339,00 072832 *
BHT – P.20 10 Bílo hliníková tmavá RAL 9007	220,00 094711	241,00 094728	339,00 094735
MZ 11 Mechově zelená RAL 6005	220,00 072870 *	241,00 072887	339,00 072894
MOT 12 Modrá tmavá RAL 5010	220,00 072849	241,00 072856	339,00 072863
TZ 13 Trávově zelená RAL 6011	220,00 073020 *	241,00 073037 *	339,00 073044 *
Balení v ks 	25	25	15
Balení v ks 	400	300	240

* Výroba na objednávku



KOLENO VÝTOKOVÉ ZIGNA 72°

P-PKV



Jmenovitá velikost	80	100	120
Cena v CZK/ks	S DPH	S DPH	S DPH
TM 1 Testa di Moro RAL 8028	220,00 095046	237,00 095053	322,00 095060
AN 2 Antracit RAL 7016	220,00 094742	237,00 094759	322,00 094766
IC 3 Intenzivní černá RAL 9005	220,00 094803	237,00 094810	322,00 094827 *
OC 4 Ocelově červená RAL 3009	220,00 094957 *	237,00 094964	322,00 094971 *
MH 5 Méděno hnědá RAL 8004	220,00 094834	237,00 094841	322,00 094858
SB 6 Šedo bílá RAL 9002	220,00 095015 *	237,00 095022	322,00 095039
BH 7 Bílo hliníková RAL 9006	220,00 094773 *	237,00 094780	322,00 094797
PS 8 Prachově šedá RAL 7037	220,00 094988 *	237,00 094995 *	322,00 095008 *
MM 9 Metalická měděná RAL extra	220,00 094865 *	237,00 094872 *	322,00 094889 *
BHT – P.20 10 Bílo hliníková tmavá RAL 9007	220,00 124739 *	237,00 124746 *	322,00 124753 *
MZ 11 Mechově zelená RAL 6005	220,00 094926 *	237,00 094933 *	322,00 094940 *
MOT 12 Modrá tmavá RAL 5010	220,00 094896 *	237,00 094902 *	322,00 094919 *
TZ 13 Trávově zelená RAL 6011	220,00 095077 *	237,00 095084 *	322,00 095091 *
Balení v ks	25	25	15
Balení v ks	400	300	180

* Výroba na objednávku

KOLENO FALCOVNÉ 72°

P-PKF2



Jmenovitá velikost	60	80	100	120
Cena v CZK/ks	S DPH	S DPH	S DPH	S DPH
TM 1 Testa di Moro RAL 8028	146,00	115,00	149,00	213,00
	071781	071798	071811	071828
Balení v ks	10	10	10	8
Balení v ks	3 000	1 200	800	576

KOLENO FALCOVNÉ 85°

P-PKF3



Jmenovitá velikost	80	100
Cena v CZK/ks	S DPH	S DPH
TM 1 Testa di Moro RAL 8028	149,00	213,00
	071804	071835
Balení v ks	10	10
Balení v ks	1 200	800

PLASTOVÝ SVODOVÝ RUKÁV

SD-ZR FOLIA KJG



Jmenovitá velikost	Délka v m	EAN číslo výrobku	Balení v m		Cena s DPH [CZK/m]
60 – 150	100,0	139726	100	6 000	13,00

SVODOVÁ ROURA [s=0,55]

P-PZR



Jmenovitá velikost	60	60	80	80	80
Délka v m	2,0	3,0	1,0	2,0	3,0
Cena v CZK/m	S DPH	S DPH	S DPH	S DPH	S DPH
TM Testa di Moro RAL 8028	1 302,00	244,00	244,00	244,00	237,00
	071309	071316	071323	071330	071347
AN Antracit RAL 7016	2 302,00	244,00	244,00	244,00	237,00
	069467	069474	069481	069498	069504
IC Intenzivní černá RAL 9005	3 302,00	244,00	244,00	244,00	237,00
	069900	069917	069924	069931	069948
OC Ocelově červená RAL 3009	4 302,00	244,00	244,00	244,00	237,00
	070661	070678	070685	070692	070708
MH Měděno hnědá RAL 8004	5 305,00		247,00	247,00	241,00
	070128		070142	070159	070166
SB Šedo bílá RAL 9002	6 305,00	274,00	247,00	247,00	241,00
	071088	071095	071101	071118	071125
BH Bílo hliníková RAL 9006	7 305,00	274,00	247,00	247,00	241,00
	069689	069696	069702	069719	069726
PS Prachově šedá RAL 7037	8 305,00	274,00	247,00	247,00	241,00
	070883	070890	070906	070913	070920
MM Metalická měděná RAL extra	9 320,00	291,00	263,00	263,00	256,00
	070340	070364	070364	070371	070388
BHT – P.20 Bílo hliníková tmavá RAL 9007	10				290,00
					096128
MZ Mechově zelená RAL 6005	11 320,00				256,00
	070586				070593
MOT Modrá tmavá RAL 5010	12 320,00				256,00
	070494				070500
TZ Trávově zelená RAL 6011	13 320,00			263,00	
	071521 *			071538	
Balení v m	10	15	10	10	15
Balení v m	490	735	100	250	375

* Výroba na objednávku

SVODOVÁ ROURA [s=0,55]
P-PZR

Jmenovitá velikost	80	80	80	100	100
Délka v m	4,0	5,0	6,0	1,0	2,0
Cena v CZK/m	S DPH	S DPH	S DPH	S DPH	S DPH
TM 1 Testa di Moro RAL 8028	237,00	237,00	237,00	251,00	251,00
	071354	071361 *	071378 *	071385	071392
AN 2 Antracit RAL 7016	237,00	237,00	237,00	251,00	251,00
	069511	069528 *	069535 *	069542	069559
IC 3 Intenzivní černá RAL 9005	237,00	237,00	237,00	251,00	251,00
	069955	069962 *	069979 *	069986	069993
OC 4 Ocelově červená RAL 3009	237,00	237,00	237,00	251,00	251,00
	070715	070722 *	070739 *	070746	070753
MH 5 Měděno hnědá RAL 8004	241,00	241,00	241,00	254,00	254,00
	070173	070180 *	070197 *	070203	070210
SB 6 Šedo bílá RAL 9002	241,00	241,00	241,00	254,00	254,00
	071132	071149 *	071156 *	071163	071170
BH 7 Bílo hliníková RAL 9006	241,00	241,00	241,00	254,00	254,00
	069733	069740 *	069757 *	069764	069771
PS 8 Prachově šedá RAL 7037	241,00	241,00	241,00	254,00	254,00
	070937	070944 *	070951 *	070968	070975
MM 9 Metalická měděná RAL extra	256,00		285,00	285,00	315,00
	070395		070401	070418	070418
BHT – P.20 10 Bílo hliníková tmavá RAL 9007					
MZ 11 Mechově zelená RAL 6005	256,00				
	070609				
MOT 12 Modrá tmavá RAL 5010					
TZ 13 Trávově zelená RAL 6011					
Balení v m	20	5	6	10	10
Balení v m	500	625	750	70	160

* Výroba na objednávku

 POZINK
 POLYESTER

SVODOVÁ ROURA [s=0,55]

P-PZR



Jmenovitá velikost	100	100	100	100	120
Délka v m	3,0	4,0	5,0	6,0	1,0
Cena v CZK/m	S DPH	S DPH	S DPH	S DPH	S DPH
TM 1 Testa di Moro RAL 8028	244,00	244,00	244,00	244,00	364,00
	071408	071415	071422	071439 *	071446
AN 2 Antracit RAL 7016	244,00	244,00	244,00	244,00	364,00
	069566	069573	069580	069597 *	069603
IC 3 Intenzivní černá RAL 9005	244,00	244,00	244,00	244,00	364,00
	070005	070012	070029	070036 *	070043
OC 4 Ocelově červená RAL 3009	244,00	244,00	244,00	244,00	364,00
	070760	070777	070784 *	070791 *	070807
MH 5 Měděno hnědá RAL 8004	247,00	247,00	247,00	247,00	368,00
	070227	070234	070241 *	070258 *	070265
SB 6 Šedo bílá RAL 9002	247,00	247,00	247,00	247,00	368,00
	071187	071194	071200 *	071217 *	071224
BH 7 Bílo hliníková RAL 9006	247,00	247,00	247,00	247,00	368,00
	069788	069795	069801 *	069818 *	069825
PS 8 Prachově šedá RAL 7037	247,00	247,00	247,00	247,00	368,00
	070982	070999	071002 *	071019 *	071026
MM 9 Metalická měděná RAL extra	278,00	278,00			390,00
	070425	070432			070449
BHT – P.20 10 Bílo hliníková tmavá RAL 9007	298,00	298,00			
	096135	096142			
MZ 11 Mechově zelená RAL 6005	278,00	278,00			
	070616	070623			
MOT 12 Modrá tmavá RAL 5010	278,00	278,00			
	070524	070531			
TZ 13 Trávově zelená RAL 6011	278,00	278,00			
	071545	071552			
Balení v m	15	20	5	6	8
Balení v m	240	320	400	480	48

* Výroba na objednávku



SVODOVÁ ROURA [s=0,55]
P-PZR

Jmenovitá velikost	120	120	120	120	120
Délka v m	2,0	3,0	4,0	5,0	6,0
Cena v CZK/m	S DPH	S DPH	S DPH	S DPH	S DPH
TM Testa di Moro RAL 8028	364,00	357,00	357,00	357,00	357,00
	071453	071460	071477	071484 *	071491 *
AN Antracit RAL 7016	364,00	357,00	357,00	357,00	357,00
	069610	069627	069634	069641 *	069658 *
IC Intenzivní černá RAL 9005	364,00	357,00	357,00	357,00	357,00
	070050	070067	070074	070081 *	070098 *
OC Ocelově červená RAL 3009	364,00	357,00	357,00	357,00	357,00
	070814	070821	070838	070845 *	070852 *
MH Měděno hnědá RAL 8004	368,00	361,00	361,00	361,00	361,00
	070272	070289	070296	070302 *	070319 *
SB Šedo bílá RAL 9002	368,00	361,00	361,00	361,00	361,00
	071231	071248	071255	071262	071279 *
BH Bílo hliníková RAL 9006	368,00	361,00	361,00	361,00	361,00
	069832	069849	069856	069863	069870 *
PS Prachově šedá RAL 7037	368,00	361,00	361,00		
	071033	071040	071057		
MM Metalická měděná RAL extra	390,00	385,00	385,00		
	070456	070463	070470		
BHT – P.20 Bílo hliníková tmavá RAL 9007		408,00			
		096159			
MZ Mechově zelená RAL 6005		385,00	385,00		
		070630	070647		
MOT Modrá tmavá RAL 5010		385,00	385,00		
		070548	070555		
TZ Trávově zelená RAL 6011		385,00	385,00		
		071569	071576		
Balení v m	10	15	20	5	6
Balení v m	120	180	240	300	360

* Výroba na objednávku



SVODOVÁ ROURA [s=0,55]
P-PZR

Jmenovitá velikost	150	150
Délka v m	3,0	4,0
Cena v CZK/m	S DPH	S DPH
TM 1 Testa di Moro RAL 8028	698,00 071507	698,00 071514
AN 2 Antracit RAL 7016	698,00 069665	698,00 069672
IC 3 Intenzivní černá RAL 9005		698,00 070111
OC 4 Ocelově červená RAL 3009		698,00 070876
MH 5 Měděno hnědá RAL 8004	701,00 070326	
SB 6 Šedo bílá RAL 9002	701,00 071286	701,00 071293
BH 7 Bílo hliníková RAL 9006	701,00 069887	701,00 069894
PS 8 Prachově šedá RAL 7037	701,00 071064	701,00 071071
MM 9 Metalická měděná RAL extra	739,00 070487	
BHT – P.20 10 Bílo hliníková tmavá RAL 9007	754,00 096166	
MZ 11 Mechově zelená RAL 6005	739,00 070654	
MOT 12 Modrá tmavá RAL 5010		739,00 070579
TZ 13 Trávově zelená RAL 6011	739,00 071583 *	
Balení v m 	3	4
Balení v m 	84	112

* Výroba na objednávku

SPOJKA SVODU

P-PSRU

Jmenovitá velikost	80	100	120
Cena v CZK/ks	S DPH	S DPH	S DPH
TM 1 Testa di Moro RAL 8028	144,00 017581	149,00 017598	166,00 017604
AN 2 Antracit RAL 7016	144,00 017284	149,00 017291	166,00 017307
IC 3 Intenzivní černá RAL 9005	144,00 017345	149,00 017352	166,00 017369
OC 4 Ocelově červená RAL 3009	144,00 017499	149,00 017505	166,00 017512
MH 5 Méděno hnědá RAL 8004	144,00 017376	149,00 017383	166,00 017390
SB 6 Šedo bílá RAL 9002	144,00 017550	149,00 017567	166,00 017574
BH 7 Bílo hliníková RAL 9006	144,00 017314	149,00 017321	166,00 017338
PS 8 Prachově šedá RAL 7037	144,00 017529	149,00 017536	166,00 017543
MM 9 Metalická měděná RAL extra	144,00 017406	149,00 017413	166,00 017420
BHT – P.20 10 Bílo hliníková tmavá RAL 9007	144,00 095657 *	149,00 095664	166,00 095671 *
MZ 11 Mechově zelená RAL 6005	144,00 017468 *	149,00 017475	166,00 017482
MOT 12 Modrá tmavá RAL 5010	144,00 017437 *	149,00 017444	166,00 017451
TZ 13 Trávově zelená RAL 6011	144,00 017611 *	149,00 017628	166,00 017635 *
Balení v ks 	10	10	8
Balení v ks 	900	900	720

* Výroba na objednávku



KOLENO SOKLOVÉ

P-PKO



Jmenovitá velikost	80	100	120
Cena v CZK/ks	S DPH	S DPH	S DPH
TM 1 Testa di Moro RAL 8028	318,00 034045	329,00 034052	473,00 034069
AN 2 Antracit RAL 7016	318,00 033741	329,00 033758	473,00 033765
IC 3 Intenzivní černá RAL 9005	318,00 033802	329,00 033819	473,00 033826
OC 4 Ocelově červená RAL 3009	318,00 033956	329,00 033963	473,00 033970
MH 5 Méděno hnědá RAL 8004	318,00 033833	329,00 033840	473,00 033857
SB 6 Šedo bílá RAL 9002	318,00 034014	329,00 034021	473,00 034038
BH 7 Bílo hliníková RAL 9006	318,00 033772	329,00 033789	473,00 033796
PS 8 Prachově šedá RAL 7037	318,00 033987	329,00 033994	473,00 034007
MM 9 Metalická měděná RAL extra	318,00 033864	329,00 033871	473,00 033888
BHT – P.20 10 Bílo hliníková tmavá RAL 9007	318,00 095688	329,00 095695	473,00 095701
MZ 11 Mechově zelená RAL 6005	318,00 033925	329,00 033932	473,00 033949
MOT 12 Modrá tmavá RAL 5010	318,00 033895	329,00 033901	473,00 033918
TZ 13 Trávnově zelená RAL 6011	318,00 034076	329,00 034083	473,00 034090
Balení v ks	20	20	15
Balení v ks	320	240	180

SVODOVÁ ODBOČKA 72°

P-PZO

Jmenovitá velikost	80/80	100/60	100/80	100/100
Cena v CZK/ks	S DPH	S DPH	S DPH	S DPH
TM 1 Testa di Moro RAL 8028	530,00 016157	590,00 016164	590,00 016171	610,00 016188
AN 2 Antracit RAL 7016	530,00 015259	590,00 015266	590,00 015273	610,00 015280
IC 3 Intenzivní černá RAL 9005	530,00 015433	590,00 015440	590,00 015457	610,00 015464
OC 4 Ocelově červená RAL 3009	530,00 015884	590,00 015891	590,00 015907	610,00 015914
MH 5 Méděno hnědá RAL 8004	530,00 015525	590,00 015532 *	590,00 015549	610,00 015556
SB 6 Šedo bílá RAL 9002	530,00 016065	590,00 016072 *	590,00 016089	610,00 016096
BH 7 Bílo hliníková RAL 9006	530,00 015341	590,00 015358 *	590,00 015365	610,00 015372
PS 8 Prachově šedá RAL 7037	530,00 015976 *	590,00 015983 *	590,00 015990	610,00 016003
MM 9 Metalická měděná RAL extra	530,00 015617	590,00 015624 *	590,00 015631	610,00 015648
BHT – P.20 10 Bílo hliníková tmavá RAL 9007	530,00 096005 *		590,00 096012 *	610,00 096029 *
MZ 11 Mechově zelená RAL 6005	530,00 015792	590,00 015808 *	590,00 015815	610,00 015822
MOT 12 Modrá tmavá RAL 5010	530,00 015709 *	590,00 015716 *	590,00 015723 *	610,00 015730
TZ 13 Trávově zelená RAL 6011	530,00 016249 *	590,00 016256 *	590,00 016263 *	610,00 016270 *
Balení v ks 	4	4	4	4
Balení v ks 	120	120	120	120

* Výroba na objednávku



SVODOVÁ ODBOČKA 72°

P-PZO



Jmenovitá velikost	120/80	120/100	120/120	150/120	150/150
Cena v CZK/ks	S DPH	S DPH	S DPH	S DPH	S DPH
TM 1 Testa di Moro RAL 8028	671,00 016195	671,00 016201	671,00 016218	976,00 016225 *	976,00 016232 *
AN 2 Antracit RAL 7016	671,00 015297	671,00 015303	671,00 015310	976,00 015327 *	976,00 015334 *
IC 3 Intenzivní černá RAL 9005	671,00 015471	671,00 015488	671,00 015495	976,00 015501 *	976,00 015518 *
OC 4 Ocelově červená RAL 3009	671,00 015921	671,00 015938	671,00 015945	976,00 015952 *	976,00 015969 *
MH 5 Méděno hnědá RAL 8004	671,00 015563	671,00 015570	671,00 015587	976,00 015594 *	976,00 015600 *
SB 6 Šedo bílá RAL 9002	671,00 016102	671,00 016119	671,00 016126	976,00 016133 *	976,00 016140 *
BH 7 Bílo hliníková RAL 9006	671,00 015389	671,00 015396	671,00 015402	976,00 015419 *	976,00 015426 *
PS 8 Prachově šedá RAL 7037	671,00 016010 *	671,00 016027	671,00 016034	976,00 016041 *	976,00 016058 *
MM 9 Metalická měděná RAL extra	671,00 015655 *	671,00 015662	671,00 015679	976,00 015686 *	976,00 015693 *
BHT – P.20 10 Bílo hliníková tmavá RAL 9007	671,00 096036 *	671,00 096043 *	671,00 096050 *		
MZ 11 Mechově zelená RAL 6005	671,00 015839 *	671,00 015846 *	671,00 015853 *	976,00 015860 *	976,00 015877 *
MOT 12 Modrá tmavá RAL 5010	671,00 015747 *	671,00 015754 *	671,00 015761 *	976,00 015778 *	976,00 015785 *
TZ 13 Trávnově zelená RAL 6011	671,00 016287 *	671,00 016294 *	671,00 016300 *	976,00 016317 *	976,00 016324 *
Balení v ks 	3	3	3	2	2
Balení v ks 	90	90	90	36	36

* Výroba na objednávku

SVODOVÝ ROZDĚLOVAČ VODY

P-PRV





Jmenovitá velikost	80	100	120
Cena v CZK/ks	S DPH	S DPH	S DPH
TM 1 Testa di Moro RAL 8028	6 607,00 088413 *	6 773,00 088420	8 775,00 088437 *
AN 2 Antracit RAL 7016	6 607,00 088116 *	6 773,00 088123	8 775,00 088130 *
IC 3 Intenzivní černá RAL 9005	6 607,00 088178 *	6 773,00 088185 *	8 775,00 088192 *
OC 4 Ocelově červená RAL 3009	6 607,00 088321 *	6 773,00 088338 *	8 775,00 088345 *
MH 5 Méděno hnědá RAL 8004	6 607,00 088208 *	6 773,00 088215 *	8 775,00 088222 *
SB 6 Šedo bílá RAL 9002	6 607,00 088383 *	6 773,00 088390 *	8 775,00 088406 *
BH 7 Bílo hliníková RAL 9006	6 607,00 088147 *	6 773,00 088154 *	8 775,00 088161 *
PS 8 Prachově šedá RAL 7037	6 607,00 088352 *	6 773,00 088369 *	8 775,00 088376 *
MM 9 Metalická měděná RAL extra	6 607,00 088239 *	6 773,00 088246 *	8 775,00 088253 *
BHT – P.20 10 Bílo hliníková tmavá RAL 9007	6 607,00 095756 *	6 773,00 095763 *	8 775,00 095770 *
MZ 11 Mechově zelená RAL 6005	6 607,00 088291 *	6 773,00 088307 *	8 775,00 088314 *
MOT 12 Modrá tmavá RAL 5010	6 607,00 088260 *	6 773,00 088277 *	8 775,00 088284 *
TZ 13 Trávově zelená RAL 6011	6 607,00 088444 *	6 773,00 088451 *	8 775,00 088468 *
Balení v ks	1	1	1
Balení v ks	–	–	–

* Výroba na objednávku

SVODOVÁ OBJÍMKA S TRNEM 150 mm



P-PO

Jmenovitá velikost	80	100	120
Cena v CZK/ks	S DPH	S DPH	S DPH
TM 1 Testa di Moro RAL 8028	112,00 002136	113,00 002143	136,00 002150
AN 2 Antracit RAL 7016	112,00 001986	113,00 001993	136,00 002006
IC 3 Intenzivní černá RAL 9005	112,00 002013	113,00 002020	136,00 002037
OC 4 Ocelově červená RAL 3009	112,00 002075	113,00 002082	136,00 002099
MH 5 Měděno hnědá RAL 8004	112,00 002044	113,00 002051	136,00 002068
SB 6 Šedo bílá RAL 9002	112,00 002105	113,00 002112	136,00 002129
Balení v ks 	25	25	25
Balení v ks 	1 000	1 000	1 000



SVODOVÁ OBJÍMKA S TRNEM 200 mm



P-POD

Jmenovitá velikost	80	100	120
Cena v CZK/ks	S DPH	S DPH	S DPH
TM 1 Testa di Moro RAL 8028	119,00 001955	119,00 001962	137,00 001979
AN 2 Antracit RAL 7016	119,00 001801	119,00 001818	137,00 001825
IC 3 Intenzivní černá RAL 9005	119,00 001832	119,00 001849	137,00 001856
OC 4 Ocelově červená RAL 3009	119,00 001894	119,00 001900	137,00 001917
MH 5 Měděno hnědá RAL 8004	119,00 001863	119,00 001870	137,00 001887
SB 6 Šedo bílá RAL 9002	119,00 001924	119,00 001931	137,00 001948
Balení v ks 	25	25	25
Balení v ks 	1 000	1 000	1 000



SVODOVÁ OBJÍMKA S TRNEM 300 mm

P-PODD

Jmenovitá velikost	100	120
Cena v CZK/ks	S DPH	S DPH
TM 1 Testa di Moro RAL 8028	154,00 002402	168,00 002419
AN 2 Antracit RAL 7016	154,00 002303	168,00 002310
IC 3 Intenzivní černá RAL 9005	154,00 002327	168,00 002334
OC 4 Ocelově červená RAL 3009	154,00 002365	168,00 002372
MH 5 Méděno hnědá RAL 8004	154,00 002341	168,00 002358
SB 6 Šedo bílá RAL 9002	154,00 002389	168,00 002396
Balení v ks  7	20	20
Balení v ks 	800	800



POZINK
POLYESTER



OBJÍMKA SE ZÁVITEM M10

P-POB

Jmenovitá velikost	60	80	100	120	150
Cena v CZK/ks	S DPH	S DPH	S DPH	S DPH	S DPH
TM 1 Testa di Moro RAL 8028	98,00 074119	90,00 074126	93,00 074133	112,00 074140	166,00 074157
AN 2 Antracit RAL 7016	98,00 073471	90,00 073488	93,00 073495	112,00 073501	166,00 073518
IC 3 Intenzivní černá RAL 9005	98,00 073679	90,00 073686	93,00 073693	112,00 073709	166,00 073716
OC 4 Ocelově červená RAL 3009	98,00 073914	90,00 073921	93,00 073938	112,00 073945	166,00 073952
MH 5 Měděno hnědá RAL 8004	98,00 073723	90,00 073730	93,00 073747	112,00 073754	166,00 073761
SB 6 Šedo bílá RAL 9002	98,00 074010	90,00 074027	93,00 074034	112,00 074041	166,00 074058
BH 7 Bílo hliníková RAL 9006	98,00 073570	90,00 073587	93,00 073594	112,00 073600	166,00 073617
PS 8 Prachově šedá RAL 7037	98,00 073969	90,00 073976	93,00 073983	112,00 073990	166,00 074003
MM 9 Metalická měděná RAL extra	98,00 073778	90,00 073785	93,00 073792	112,00 073808	166,00 077158
BHT – P.20 10 Bílo hliníková tmavá RAL 9007	98,00 119711	90,00 094537	93,00 094544	112,00 094551	166,00 094674
MZ 11 Mechově zelená RAL 6005	98,00 073860	90,00 073877	93,00 073884	112,00 073891	166,00 073907
MOT 12 Modrá tmavá RAL 5010	98,00 073815	90,00 073822	93,00 073839	112,00 073846	166,00 073853
TZ 13 Trávově zelená RAL 6011	98,00 074164 *	90,00 074171	93,00 074188	112,00 074195	166,00 074201 *
Balení v ks 	25	25	25	25	20
Balení v ks 	3 000	3 000	3 000	3 000	2 400

* Výroba na objednávku



OBJÍMKA SE ZÁVÍTEM M8

P-POB





Jmenovitá velikost	60	80	100	120	150
Cena v CZK/ks	S DPH	S DPH	S DPH	S DPH	S DPH
TM 1 Testa di Moro RAL 8028	98,00	90,00	93,00	112,00	166,00
	074065	074072	074089	074096	074102
AN 2 Antracit RAL 7016	98,00	90,00	93,00	112,00	166,00
	073426	073433	073440	073457	073464
IC 3 Intenzivní černá RAL 9005	98,00	90,00	93,00	112,00	166,00
	073624	073631	073648	073655	073662
BH 7 Bílo hliníková RAL 9006	98,00	90,00	93,00	112,00	166,00
	073532	073525	073549	073556	073563
Balení v ks	25	25	25	25	20
Balení v ks	3 000	3 000	3 000	3 000	2 400



SKRUTKA PRO OBJÍMKY M6x20

P-POB-NSK





Jmenovitá velikost	EAN číslo výrobku	Balení v ks		Cena s DPH [CZK/ks]
				
M6 x 20 *	071675	1	–	5,00

* Výroba na objednávku

ŠROUB PRO OBJÍMKU SE ZÁVITOVOU MATKOU TORX M10

P-POB-HT





Jmenovitá velikost	EAN číslo výrobku	Balení v ks		Cena s DPH [CZK/ks]
				
80	002464	100	40 000	34,00
140	002471	100	28 000	42,00
200	002488	100	20 000	53,00
250	002495	100	16 000	58,00
300	002501	100	11 200	58,00

HMOŽDINKA BEZ LAMELY M10

P-POB-HN DB





Jmenovitá velikost	EAN číslo výrobku	Balení v ks		Cena s DPH [CZK/ks]
				
120	002426	100	25 000	14,00

HMOŽDINKA S LAMELOU M10

P-POB-HN DB





Jmenovitá velikost	EAN číslo výrobku	Balení v ks		Cena s DPH [CZK/ks]
				
180	002433	100	12 000	14,00
240	002440	100	12 000	17,00
280	002457	100	12 000	18,00

KOMBISKRUTKA TORX M10

P-POB-ZT/SZ



Jmenovitá velikost	EAN číslo výrobku	Balení v ks		Cena s DPH [CZK/ks]
				
140	002587	50	10 400	15,00
180	002594	50	10 400	19,00

HMOŽDINKA PRO HRANATÝ HROT OBJÍMKY 7x7

P-POB-HN R1



Jmenovitá velikost	EAN číslo výrobku	Balení v ks		Cena s DPH [CZK/ks]
200/60	002600	250	15 000	6,00

IZOLAČNÍ HMOŽDINKA M10

P-POB-HN IZOL



Jmenovitá velikost	EAN číslo výrobku	Balení v ks		Cena s DPH [CZK/ks]
M10 x 96	001207	25	2 625	100,00

ZÁVITOVÁ TYČ M10

P-POB-ZT



Jmenovitá velikost	EAN číslo výrobku	Balení v ks		Cena s DPH [CZK/ks]
60	002556	100	20 800	7,00
100	002563	100	15 600	10,00
150	002570	50	10 400	19,00

MONTÁŽNÍ PLATNA M10

P-POB-ZT MP





Jmenovitá velikost	EAN číslo výrobku	Balení v ks		Cena s DPH [CZK/ks]
80 x 30	002518	25	5 200	39,00

ŠROUB PRO OBJÍMKU SE ZÁVITOVOU MATKOU M8

P-POB-HB





Jmenovitá velikost	EAN číslo výrobku	Balení v ks		Cena s DPH [CZK/ks]
				
150	071590	100	5 000	22,00
200	071606	100	5 000	31,00
250	071613	100	5 000	36,00
300	071620	100	5 000	37,00

HMOŽDINKA M8

P-POB-HBN-SS











Jmenovitá velikost	EAN číslo výrobku	Balení v ks		Cena s DPH [CZK/ks]
				
150	071637	100	5 000	7,00
200	071644	100	5 000	8,00
250	071651	100	5 000	8,00
300	071668	100	8 000	13,00

POZINK
POLYESTER

KRYTKA PRO ŠROUB OBJÍMKY

P-POB-HT AKG



Jmenovitá velikost	EAN číslo výrobku	Balení v ks		Cena s DPH [CZK/ks]
				
 29 x 13	002280	50	16 800	8,00
 29 x 13	002211	50	16 800	8,00
 29 x 13	002235	50	16 800	8,00
 29 x 13	002266	50	16 800	8,00
 29 x 13	002242	50	16 800	8,00
  29 x 13	002228	50	16 800	8,00
   29 x 13	002273	50	16 800	8,00
 29 x 13	002259	50	16 800	8,00
 29 x 13	002297	50	16 800	8,00

DEŠŤOVÁ KLAPKA

P-PZV



Jmenovitá velikost	80	100	120
Cena v CZK/ks	S DPH	S DPH	S DPH
TM 1 Testa di Moro RAL 8028	425,00 034533	439,00 034540	644,00 034557
AN 2 Antracit RAL 7016	425,00 034410	439,00 034427	644,00 034434
IC 3 Intenzivní černá RAL 9005	425,00 034441	439,00 034458	644,00 034465
OC 4 Ocelově červená RAL 3009	425,00 034502	439,00 034519	644,00 034526
MH 5 Méděno hnědá RAL 8004	425,00 034472	439,00 034489	644,00 034496
Balení v ks	6	5	3
Balení v ks	180	150	90

DEŠŤOVÁ KLAPKA S LAPAČEM LISTÍ

P-PZVS



Jmenovitá velikost	80	100	120
Cena v CZK/ks	S DPH	S DPH	S DPH
TM 1 Testa di Moro RAL 8028	425,00 034861	439,00 034878	644,00 034885
AN 2 Antracit RAL 7016	425,00 034564	439,00 034571	644,00 034588
IC 3 Intenzivní černá RAL 9005	425,00 034625	439,00 034632	644,00 034649
OC 4 Ocelově červená RAL 3009	425,00 034779	439,00 034786	644,00 034793
MH 5 Méděno hnědá RAL 8004	425,00 034656	439,00 034663	644,00 034670
SB 6 Šedo bílá RAL 9002	425,00 034830	439,00 034847	644,00 034854
BH 7 Bílo hliníková RAL 9006	425,00 034595	439,00 034601	644,00 034618
PS 8 Prachově šedá RAL 7037	425,00 034809	439,00 034816	644,00 034823
MM 9 Metalická měděná RAL extra	425,00 034687	439,00 034694	644,00 034700
BHT – P.20 10 Bílo hliníková tmavá RAL 9007	425,00 095718	439,00 095725	644,00 095732
MZ 11 Mechově zelená RAL 6005	425,00 034748	439,00 034755	644,00 034762
MOT 12 Modrá tmavá RAL 5010	425,00 034717	439,00 034724	644,00 034731
TZ 13 Trávnově zelená RAL 6011	425,00 034892 *	439,00 034908	644,00 034915
Balení v ks	6	5	3
Balení v ks	180	150	90

* Výroba na objednávku

HLINÍKOVÝ SBĚRAČ DEŠŤOVÉ VODY S HADICÍ

P-PZVHA

Jmenovitá velikost	80	100	120
Cena v CZK/ks	S DPH	S DPH	S DPH
TM 1 Testa di Moro RAL 8028	2 202,00 018793	2 202,00 018809	4 523,00 018816
AN 2 Antracit RAL 7016	2 202,00 018496	2 202,00 018502	4 523,00 018519
IC 3 Intenzivní černá RAL 9005	2 202,00 018557	2 202,00 018564	4 523,00 018571
OC 4 Ocelově červená RAL 3009	2 202,00 018700	2 202,00 018717	4 523,00 018724 *
MH 5 Méděno hnědá RAL 8004	2 202,00 018588 *	2 202,00 018595	4 523,00 018601 *
SB 6 Šedo bílá RAL 9002	2 202,00 018762 *	2 202,00 018779	4 523,00 018786
BH 7 Bílo hliníková RAL 9006	2 202,00 018526	2 202,00 018533	4 523,00 018540
PS 8 Prachově šedá RAL 7037	2 202,00 018731 *	2 202,00 018748	4 523,00 018755 *
MM 9 Metalická měděná RAL extra	2 202,00 018618 *	2 202,00 018625 *	4 523,00 018632 *
BHT – P.20 10 Bílo hliníková tmavá RAL 9007	2 202,00 095527 *	2 202,00 095534 *	4 523,00 095541 *
MZ 11 Mechově zelená RAL 6005	2 202,00 018670 *	2 202,00 018687	4 523,00 018694 *
MOT 12 Modrá tmavá RAL 5010	2 202,00 018649 *	2 202,00 018656 *	4 523,00 018663 *
TZ 13 Trávově zelená RAL 6011	2 202,00 018823 *	2 202,00 018830 *	4 523,00 018847 *
Balení v ks 	1	1	1
Balení v ks 	60	60	60

* Výroba na objednávku



SVOD OCHRANNÝ S REVIZNÍM OTVOREM

P-POZR





Jmenovitá velikost	80	100	100
Délka v m	1,0	1,0	1,5
Cena v CZK/m	S DPH	S DPH	S DPH
TM 1 Testa di Moro RAL 8028	2 168,00 010254 *	1 660,00 010261	3 286,00 010278
AN 2 Antracit RAL 7016	2 168,00 009760 *	1 660,00 009777	3 286,00 009784 *
IC 3 Intenzivní černá RAL 9005	2 168,00 009869 *	1 660,00 009876	3 286,00 009883 *
OC 4 Ocelově červená RAL 3009	2 168,00 010117 *	1 660,00 010124 *	3 286,00 010131 *
MH 5 Měděno hnědá RAL 8004	2 168,00 009913 *	1 660,00 009920 *	3 286,00 009937 *
SB 6 Šedo bílá RAL 9002	2 168,00 010209 *	1 660,00 010247 *	3 286,00 010216 *
BH 7 Bílo hliníková RAL 9006	2 168,00 009814 *	1 660,00 009821 *	3 286,00 009838 *
PS 8 Prachově šedá RAL 7037	2 168,00 010162 *	1 660,00 010179 *	3 286,00 010186 *
MM 9 Metalická měděná RAL extra	2 168,00 009968 *	1 660,00 009975 *	3 286,00 009982 *
BHT – P.20 10 Bílo hliníková tmavá RAL 9007	2 168,00 096494 *	1 660,00 096500 *	
MZ 11 Mechově zelená RAL 6005	2 168,00 010063 *	1 660,00 010070 *	3 286,00 010087 *
MOT 12 Modrá tmavá RAL 5010	2 168,00 010018 *	1 660,00 010025 *	3 286,00 010032 *
TZ 13 Trávově zelená RAL 6011	2 168,00 010308 *	1 660,00 010315 *	3 286,00 010322 *
Balení v ks	1	1	1
Balení v ks	70	60	60

* Výroba na objednávku

POZINK POLYESTER

SVOD OCHRANNÝ S REVIZNÍM OTVOREM



P-POZR

Jmenovitá velikost	120	120
Délka v m	1,0	1,5
Cena v CZK/m	S DPH	S DPH
TM 1 Testa di Moro RAL 8028	3 896,00	5 590,00
	010285	010292 *
AN 2 Antracit RAL 7016	3 896,00	5 590,00
	009791 *	009807 *
IC 3 Intenzivní černá RAL 9005	3 896,00	5 590,00
	009890 *	009906 *
OC 4 Ocelově červená RAL 3009	3 896,00	5 590,00
	010148 *	010155 *
MH 5 Méděno hnědá RAL 8004	3 896,00	5 590,00
	009944 *	009951 *
SB 6 Šedo bílá RAL 9002	3 896,00	5 590,00
	010223 *	010230 *
BH 7 Bílo hliníková RAL 9006	3 896,00	5 590,00
	009845 *	009852 *
PS 8 Prachově šedá RAL 7037	3 896,00	5 590,00
	010193 *	009753 *
MM 9 Metalická měděná RAL extra	3 896,00	5 590,00
	009999 *	010001 *
BHT – P.20 10 Bílo hliníková tmavá RAL 9007	3 896,00	5 590,00
	096517 *	
MZ 11 Mechově zelená RAL 6005	3 896,00	5 590,00
	010094 *	010100 *
MOT 12 Modrá tmavá RAL 5010	3 896,00	5 590,00
	010049 *	010056 *
TZ 13 Trávově zelená RAL 6011	3 896,00	5 590,00
	010339 *	010346 *
Balení v ks 	1	1
Balení v ks 	40	40

* Výroba na objednávku

OBJÍMKA S GUMOU M10

P-POB-OZR

Jmenovitá velikost	EAN číslo výrobku	Balení v ks		Cena s DPH [CZK/ks]
				
80	002525	25	1 250	53,00
100	002532	25	1 250	68,00
120	002549	20	1 000	76,00



